



Technical Data  
Data Sheet N0668, Rev. -

*Green Products*

**16CTQ200/16CTQ200S /16CTQ200-1**  
**SCHOTTKY RECTIFIER**

**Applications:**

- Switching power supply
- Converters
- Free-Wheeling diodes
- Reverse battery protection

**Features:**

- 175°C T<sub>J</sub> operation
- Center tap configuration
- Low forward voltage drop
- High purity, high temperature epoxy encapsulation for enhanced mechanical strength and moisture resistance
- High frequency operation
- Guard ring for enhanced ruggedness and long term reliability
- This is a Pb – Free Device
- All SMC parts are traceable to the wafer lot
- Additional testing can be offered upon request

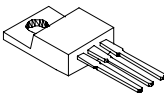
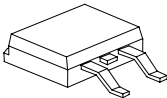
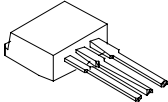
| Case styles   |  |   |
|---|--|---|
| <b>16CTQ200</b><br><br><br><br><b>TO-220AB</b> | <b>16CTQ200S</b><br><br><br><br><b>D<sup>2</sup>PAK</b> | <b>16CTQ200-1</b><br><br><br><br><b>TO-262</b> |

**Mechanical Dimensions: In Inches / mm**

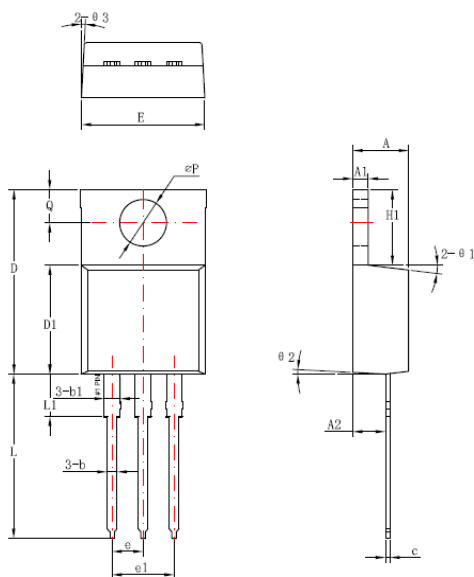

| Symbol | Dimensions in millimeters |         |       |
|--------|---------------------------|---------|-------|
|        | Min                       | Typical | Max   |
| A      | 4.42                      | 4.57    | 4.72  |
| A1     | 1.17                      | 1.27    | 1.37  |
| A2     | 2.59                      | 2.69    | 2.89  |
| b      | 0.71                      | 0.81    | 0.96  |
| b1     |                           | 1.27    |       |
| c      | 0.36                      | 0.38    | 0.61  |
| D      | 14.94                     | 15.24   | 15.54 |
| D1     | 8.85                      | 9.00    | 9.15  |
| E      | 10.01                     | 10.16   | 10.31 |
| e      |                           | 2.54    |       |
| e1     |                           | 5.06    |       |
| H1     | 6.04                      | 6.24    | 6.44  |
| L      | 12.7                      | 13.56   | 13.78 |
| L1     |                           | 3.5     |       |
| ΦP     | 3.74                      | 3.84    | 4.04  |
| Q      | 2.54                      | 2.74    | 2.94  |
| θ1     |                           | 7°      |       |
| θ2     |                           | 3°      |       |
| θ3     |                           | 4°      |       |

**TO-220AB**

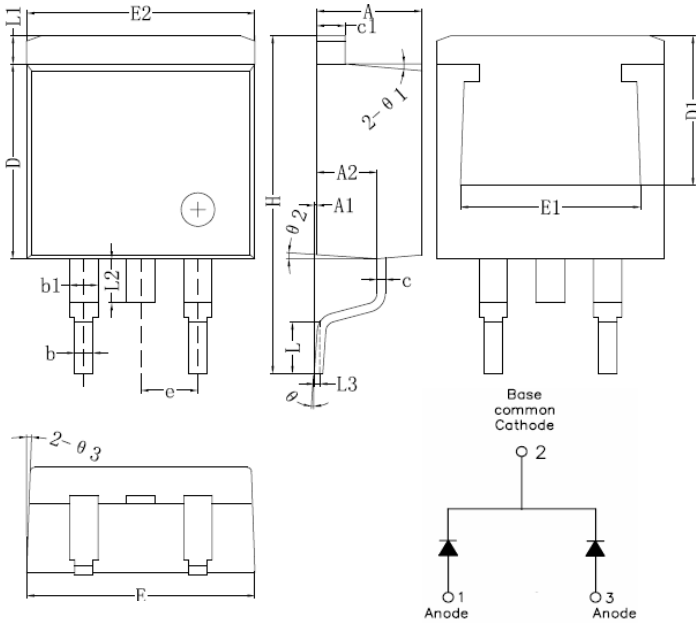

| Symbol | Dimensions in millimeters |         |       |
|--------|---------------------------|---------|-------|
|        | Min.                      | Typical | Max.  |
| A      | 4.55                      | 4.70    | 4.85  |
| A1     | 0                         | 0.10    | 0.25  |
| A2     | 2.59                      | 2.69    | 2.89  |
| b      | 0.71                      | 0.81    | 0.96  |
| b1     |                           | 1.27    |       |
| c      | 0.36                      | 0.38    | 0.61  |
| c1     | 1.17                      | 1.27    | 1.37  |
| D      | 8.55                      | 8.70    | 8.85  |
| D1     | 6.40                      |         |       |
| E      | 10.01                     | 10.16   | 10.31 |
| E1     | 7.6                       |         |       |
| E2     | 9.98                      | 10.08   | 10.18 |
| e      |                           | 2.54    |       |
| H      | 14.6                      | 15.1    | 15.6  |
| L      | 2.00                      | 2.30    | 2.70  |
| L1     | 1.17                      | 1.27    | 1.40  |
| L2     |                           |         | 2.20  |
| L3     |                           | 0.25BSC |       |
| e      | 0                         | -       | 8°    |
| e1     |                           | 5°      |       |
| e2     |                           | 4°      |       |
| e3     |                           | 4°      |       |

**D<sup>2</sup>PAK**

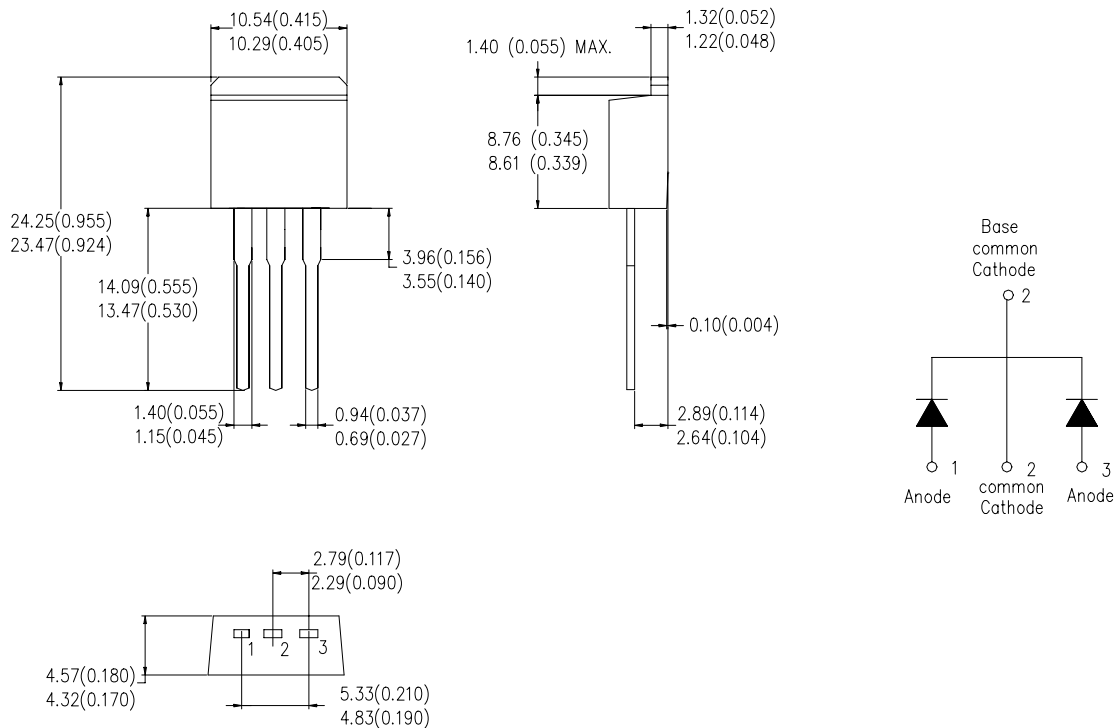

**TO-262**

Marking Diagram:

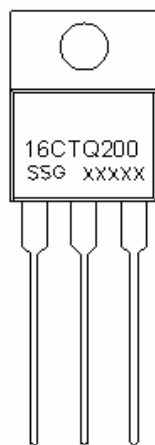

16CTQ200

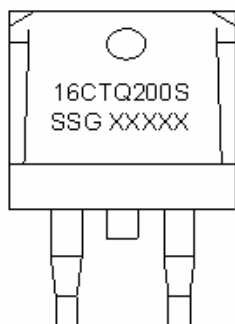

16CTQ200S

Where XXXXX is YYWWL

16CTQ200 = Part Name  
SSG = SSG  
YY = Year  
WW = Week  
L = Lot Number

**Cautions:** Molding resin  
Epoxy resin UL:94V-0

Ordering Information:

| Device    | Package                         | Shipping      |
|-----------|---------------------------------|---------------|
| 16CTQ200  | TO-220AB<br>(Pb-Free)           | 50pcs / tube  |
| 16CTQ200S | D <sup>2</sup> PAK<br>(Pb-Free) | 800pcs / reel |

For information on tape and reel specifications, including part orientation and tape sizes, please refer to our Tape and Reel Packaging Specification.

Maximum Ratings:

| Characteristics  | Symbol      | Condition   | Max.           | Units |
|--|-------------|---|----------------|-------|
| Peak Inverse Voltage   | $V_{RWM}$   | -   | 200            | V     |
| Max. Average Forward   | $I_{F(AV)}$ | 50% duty cycle @ $T_C = 154^\circ\text{C}$ ,<br>rectangular wave form | 8(per leg)     | A     |
|  |             |   | 16(per device) |       |
| Max. Peak One Cycle<br>Non-Repetitive Surge Current<br>(per leg) | $I_{FSM}$   | 8.3 ms, half Sine pulse   | 330            | A     |

**Electrical Characteristics:**

| Characteristics                                    | Symbol          | Condition   | Max.   | Units |
|--|-----------------|---|--------|-------|
| Max. Forward Voltage Drop (per leg)*               | V <sub>F1</sub> | @ 8A, Pulse, T <sub>J</sub> = 25 °C                                     | 0.84   | V     |
|  | V <sub>F2</sub> | @ 8A, Pulse, T <sub>J</sub> = 125 °C                                    | 0.70   | V     |
| Max. Reverse Current at DC condition               | I <sub>R1</sub> | @V <sub>R</sub> = rated V <sub>R</sub><br>T <sub>J</sub> = 25 °C        | 1.0    | mA    |
| Max. Reverse Current                               | I <sub>R2</sub> | @V <sub>R</sub> = rated V <sub>R</sub><br>T <sub>J</sub> = 125 °C       | 7.0    | mA    |
| Max. Junction Capacitance                          | C <sub>T</sub>  | @V <sub>R</sub> = 5V, T <sub>C</sub> = 25 °C<br>f <sub>SIG</sub> = 1MHz | 300    | pF    |
| Typical Series Inductance                          | L <sub>S</sub>  | Measured lead to lead 5 mm from package body                            | 8.0    | nH    |
| Max. Voltage Rate of Change(Rated V <sub>R</sub> ) | dv/dt           | -   | 10,000 | V/μs  |

\* Pulse Width < 300μs, Duty Cycle <2%

**Thermal-Mechanical Specifications:**

| Characteristics                                       | Symbol  | Condition                            | Specification | Units |
|---|---|--------------------------------------|---------------|-------|
| Max. Junction Temperature                             | T <sub>J</sub>  | -                                    | -55 to +175   | °C    |
| Max. Storage Temperature                              | T <sub>stg</sub>  | -                                    | -55 to +175   | °C    |
| Maximum Thermal Resistance Junction to Case (per leg) | R <sub>θJC</sub>  | DC operation                         | 3.25          | °C/W  |
| Typical Thermal Resistance,case to Heat Sink          | R <sub>θcs</sub>  | Mounting surface, smooth and greased | 0.50          | °C/W  |
| Approximate Weight                                    | wt  | -                                    | 2             | g     |
| Case Style  | TO-220AB,D <sup>2</sup> PAK,TO-262(Suffix“s”for D <sup>2</sup> PAK; Suffix“-1”for TO-262) |                                      |               |       |



**Typical Forward Characteristics**

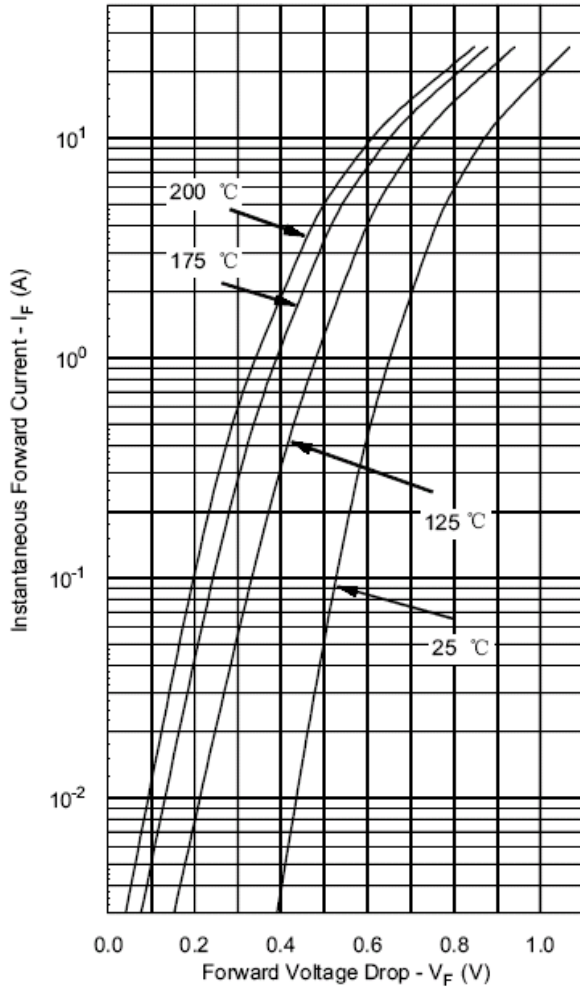

**Typical Reverse Characteristics**

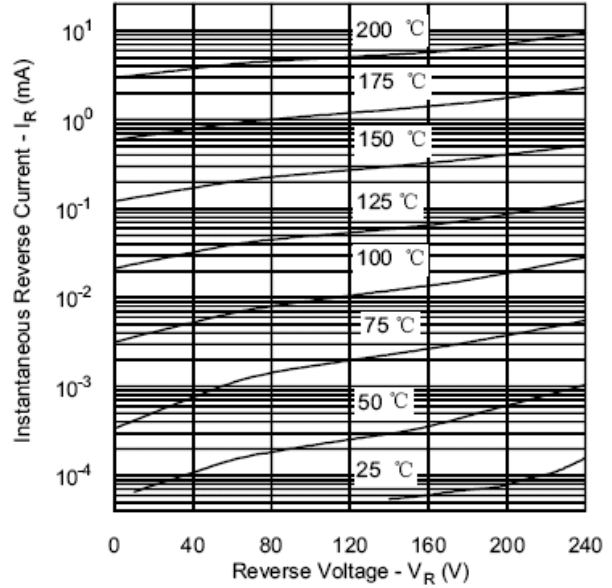

**Typical Junction Capacitance**

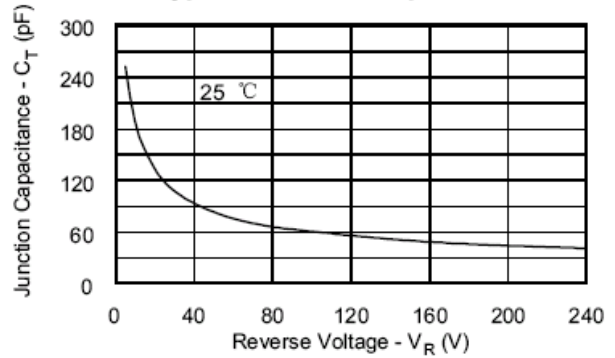

**DISCLAIMER:**

1- The information given herein, including the specifications and dimensions, is subject to change without prior notice to improve product characteristics. Before ordering, purchasers are advised to contact the SMC - Sangdest Microelectronics (Nanjing) Co., Ltd sales department for the latest version of the datasheet(s).

2- In cases where extremely high reliability is required (such as use in nuclear power control, aerospace and aviation, traffic equipment, medical equipment, and safety equipment), safety should be ensured by using semiconductor devices that feature assured safety or by means of users' fail-safe precautions or other arrangement.

3- In no event shall SMC - Sangdest Microelectronics (Nanjing) Co., Ltd be liable for any damages that may result from an accident or any other cause during operation of the user's units according to the datasheet(s). SMC - Sangdest Microelectronics (Nanjing) Co., Ltd assumes no responsibility for any intellectual property claims or any other problems that may result from applications of information, products or circuits described in the datasheets.

4- In no event shall SMC - Sangdest Microelectronics (Nanjing) Co., Ltd be liable for any failure in a semiconductor device or any secondary damage resulting from use at a value exceeding the absolute maximum rating.

5- No license is granted by the datasheet(s) under any patents or other rights of any third party or SMC - Sangdest Microelectronics (Nanjing) Co., Ltd.

6- The datasheet(s) may not be reproduced or duplicated, in any form, in whole or part, without the expressed written permission of SMC - Sangdest Microelectronics (Nanjing) Co., Ltd.

7- The products (technologies) described in the datasheet(s) are not to be provided to any party whose purpose in their application will hinder maintenance of international peace and safety nor are they to be applied to that purpose by their direct purchasers or any third party. When exporting these products (technologies), the necessary procedures are to be taken in accordance with related laws and regulations..