

Smart High-Side Power Switch



Functions

- Very low standby current
- CMOS compatible input
- Fast demagnetization of inductive loads
- Stable behaviour at undervoltage
- Wide operating voltage range
- Logic ground independent from load ground
- Short circuit protection
- Overload protection
- Current limitation
- Thermal shutdown
- Overvoltage protection (including load dump) with external resistor
- Reverse battery protection with external resistor
- Loss of ground and loss of V_{bb} protection
- Electrostatic discharge protection (ESD)
- Green Product (RoHS compliant)
- AEC Qualified

Product Summary

Operating voltage	$V_{bb(on)}$	4.7... 41	V
On-state resistance	R_{ON}	38	m Ω
Nominal load current	$I_{L(NOM)}$	9.8	A
Current limitation	$I_{L(SCr)}$	40	A



Applications

- μ C compatible high-side power switch with diagnostic feedback for 5V, 12V and 24V grounded loads
- All types of resistive, inductive and capacitive loads
- Most suitable for loads with high inrush currents, so as lamps
- Replaces electromechanical relays, fuses and discrete circuits

General Description

- N channel vertical power MOSFET with charge pump, ground referenced CMOS compatible input and diagnostic feedback, monolithically integrated in Smart SIPMOS[®] technology.
- Providing embedded protective functions

Diagnostic Function

- Diagnostic feedback with open drain output
- Open load detection in ON-state
- Feedback of thermal shutdown in ON-state

Functional diagram

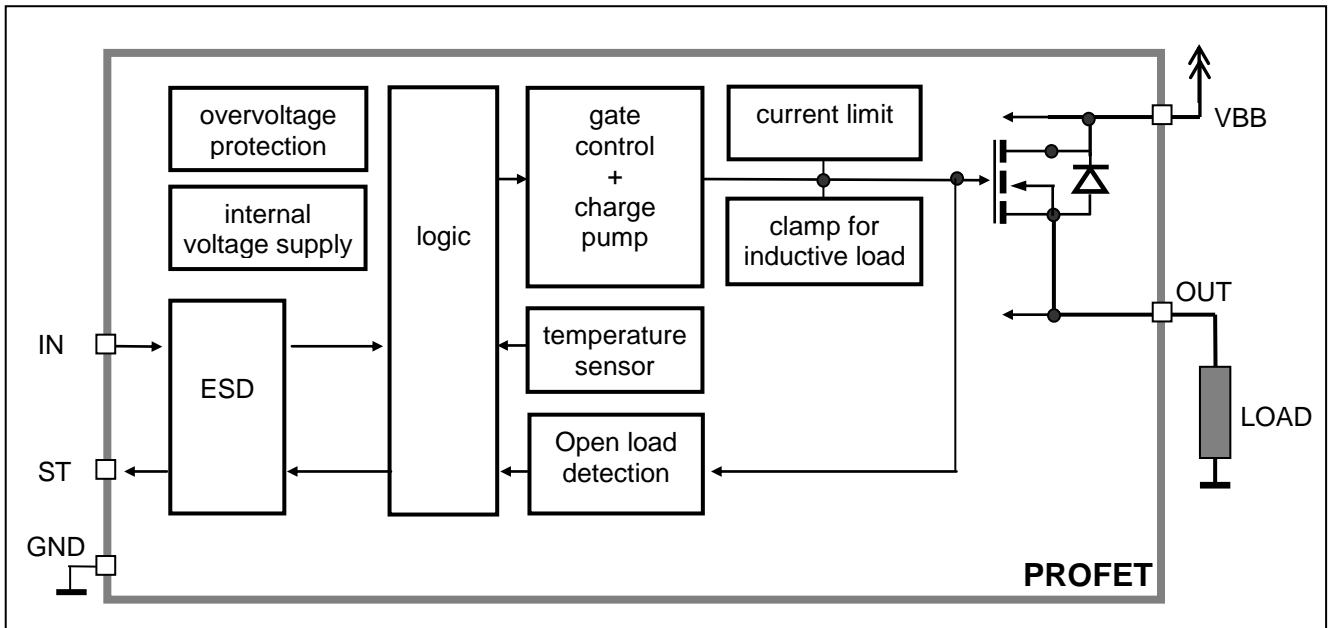

Pin Definitions and Functions

Pin	Symbol	Function
1	GND	Logic ground
2	IN	Input , activates the power switch in case of logical high signal
3	V _{bb}	Positive power supply voltage The tab is shorted to pin 3
4	ST	Diagnostic feedback , low on failure
5	OUT	Output to the load
Tab	V _{bb}	Positive power supply voltage The tab is shorted to pin 3

Pin configuration

(top view)

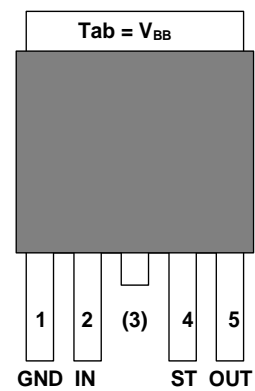

Maximum Ratings at $T_j = 25\text{ °C}$ unless otherwise specified

Parameter	Symbol	Values	Unit
Supply voltage (overvoltage protection see page 4)	V_{bb}	43	V
Supply voltage for short circuit protection $T_{j\text{ Start}} = -40 \dots +150\text{ °C}$	V_{bb}	24	V
Load dump protection ¹⁾ $V_{\text{LoadDump}} = V_A + V_S$, $V_A = 13.5\text{ V}$ $R_1^2) = 2\ \Omega$, $R_L = 4.0\ \Omega$, $t_d = 200\text{ ms}$, IN= low or high	$V_{\text{Load dump}}^3$	60	V
Load current (Current limit, see page 5)	I_L	self-limited	A
Operating temperature range	T_j	-40 ... +150	°C
Storage temperature range	T_{stg}	-55 ... +150	
Power dissipation (DC), $T_C \leq 25\text{ °C}$	P_{tot}	75	W
Maximal switchable inductance, single pulse $V_{bb} = 12\text{V}$, $T_{j,\text{start}} = 150\text{ °C}$, $T_C = 150\text{ °C}$ const. (See diagram on page 8) $I_L(\text{ISO}) = 9.8\text{ A}$, $R_L = 0\ \Omega$, $E_{AS}^4) = 0.33\text{J}$:	Z_L	5.0	mH
Electrostatic discharge capability (ESD) IN: (Human Body Model) ST: out to all other pins shorted: acc. MIL-STD883D, method 3015.7 and ESD assn. std. S5.1-1993; $R = 1.5\text{k}\Omega$; $C = 100\text{pF}$	V_{ESD}	1.0 4.0 8.0	kV
Input voltage (DC)	V_{IN}	-10 ... +16	V
Current through input pin (DC)	I_{IN}	± 2.0	mA
Current through status pin (DC) see internal circuit diagrams page 7	I_{ST}	± 5.0	

Thermal Characteristics

Parameter and Conditions	Symbol	Values			Unit
		min	typ	max	
Thermal resistance chip - case:	R_{thJC}	--	--	1.75	K/W
junction - ambient (free air):	R_{thJA}	--	--	75	
device on pcb ⁵⁾ :		--	33	--	

¹⁾ Supply voltages higher than $V_{bb(\text{AZ})}$ require an external current limit for the GND and status pins (a $150\ \Omega$ resistor for the GND connection is recommended).

²⁾ R_1 = internal resistance of the load dump test pulse generator

³⁾ $V_{\text{Load dump}}$ is setup without the DUT connected to the generator per ISO 7637-1 and DIN 40839



⁴⁾ E_{AS} is the maximum inductive switch-off energy

⁵⁾ Device on $50\text{mm} \times 50\text{mm} \times 1.5\text{mm}$ epoxy PCB FR4 with 6cm^2 (one layer, $70\ \mu\text{m}$ thick) copper area for V_{bb} connection. PCB is vertical without blown air.

Electrical Characteristics

Parameter and Conditions at $T_j = -40 \dots +150^\circ\text{C}$, $V_{bb} = 12\text{ V}$ unless otherwise specified	Symbol	Values			Unit
		min	typ	max	

Load Switching Capabilities and Characteristics

On-state resistance (pin 3 to 5) $I_L = 2\text{ A}$; $V_{BB} \geq 7\text{ V}$ $T_j = 25^\circ\text{C}$: $T_j = 150^\circ\text{C}$: see diagram, page 9	R_{ON}	--	35 64	38 72	$\text{m}\Omega$
Nominal load current, (pin 3 to 5) ISO 10483-1, 6.7: $V_{ON} = 0.5\text{ V}$, $T_C = 85^\circ\text{C}$	$I_{L(ISO)}$	8.8	9.8	--	A
Output current (pin 5) while GND disconnected or GND pulled up ⁶⁾ , $V_{bb} = 30\text{ V}$, $V_{IN} = 0$, see diagram page 7	$I_{L(GNDhigh)}$	--	--	2	mA
Turn-on time IN  to 90% V_{OUT} : $R_L = 12\ \Omega$,	t_{on}	50	100	200	μs
Turn-off time IN  to 10% V_{OUT} : $R_L = 12\ \Omega$,	t_{off}	50	120	250	μs
Slew rate on 10 to 30% V_{OUT} , $R_L = 12\ \Omega$,	dV/dt_{on}	0.1	--	1	$\text{V}/\mu\text{s}$
Slew rate off 70 to 40% V_{OUT} , $R_L = 12\ \Omega$,	$-dV/dt_{off}$	0.1	--	1	$\text{V}/\mu\text{s}$

Operating Parameters

Operating voltage $T_j = -40$ $T_j = +25 \dots +150^\circ\text{C}$:	$V_{bb(on)}$	4.75	-- --	41 43	V
Overvoltage protection ⁷⁾ $I_{bb} = 40\text{ mA}$ $T_j = -40^\circ\text{C}$: $T_j = 25 \dots +150^\circ\text{C}$:	$V_{bb(AZ)}$	41 43	-- 47	-- 52	V
Standby current (pin 3) ⁸⁾ $V_{IN} = 0$; see diagram on page 9 $T_j = -40 \dots +25^\circ\text{C}$: $T_j = 150^\circ\text{C}$:	$I_{bb(off)}$	-- --	5 --	8 25	μA
Off-State output current (included in $I_{bb(off)}$) $V_{IN} = 0$	$I_{L(off)}$	--	1	10	μA
Operating current ⁹⁾ , $V_{IN} = 5\text{ V}$	I_{GND}	--	0.8	1.4	mA

⁶⁾ not subject to production test, specified by design

⁷⁾ Supply voltages higher than $V_{bb(AZ)}$ require an external current limit for the GND and status pins (a $150\ \Omega$ resistor for the GND connection is recommended. See also $V_{ON(CL)}$ in table of protection functions and circuit diagram page 7.

⁸⁾ Measured with load



⁹⁾ Add I_{ST} , if $I_{ST} > 0$, add I_{IN} , if $V_{IN} > 5.5\text{ V}$

Parameter and Conditions at $T_j = -40...+150^\circ\text{C}$, $V_{bb} = 12\text{ V}$ unless otherwise specified	Symbol	Values			Unit	
		min	typ	max		
Protection Functions¹⁰⁾						
Current limit (pin 3 to 5) (see timing diagrams on page 11)	$I_{L(\text{lim})}$					
		$T_j = -40^\circ\text{C}$: $T_j = 25^\circ\text{C}$: $T_j = +150^\circ\text{C}$:	46 39 30	58 51 38	68 58 46	A
Repetitive short circuit shutdown current limit $T_j = T_{jt}$ (see timing diagrams, page 11)	$I_{L(\text{SCR})}$		--	40	--	A
Thermal shutdown time ¹¹⁾ (see timing diagrams on page 11)	$T_{j,\text{start}} = 25^\circ\text{C}$: $t_{\text{off}(\text{SC})}$		--	1.9	--	ms
Output clamp (inductive load switch off) at $V_{\text{OUT}} = V_{bb} - V_{\text{ON}(\text{CL})}$	$I_L = 40\text{ mA}$: $V_{\text{ON}(\text{CL})}$		41 43	47	52	V
Thermal overload trip temperature	T_{jt}		150	--	--	$^\circ\text{C}$
Thermal hysteresis	ΔT_{jt}		--	10	--	K
Reverse battery (pin 3 to 1) ¹²⁾	$-V_{bb}$		--	--	32	V
Reverse battery voltage drop ($V_{\text{out}} > V_{bb}$) ¹³⁾ $I_L = -2\text{ A}$	$T_j = 150^\circ\text{C}$: $-V_{\text{ON}(\text{rev})}$		--	600	--	mV

Diagnostic Characteristics

Open load detection current (on-condition)	$I_L(\text{OL})$		100	--	900	mA
---	------------------	--	-----	----	-----	----

Input and Status Feedback¹⁴⁾

Input resistance see circuit page 7	R_i		2.5	3.5	6	k Ω
Input turn-on threshold voltage 	$V_{\text{IN}(\text{T}+)}$		1.7	--	3.2	V
Input turn-off threshold voltage 	$V_{\text{IN}(\text{T}-)}$		1.5	--	--	V
Input threshold hysteresis	$\Delta V_{\text{IN}(\text{T})}$		--	0.5	--	V
Off state input current (pin 2), $V_{\text{IN}} = 0.4\text{ V}$	$I_{\text{IN}(\text{off})}$		1	--	50	μA
On state input current (pin 2), $V_{\text{IN}} = 5\text{ V}$	$I_{\text{IN}(\text{on})}$		20	50	90	μA
Delay time for status with open load after switch off (see timing diagrams on page 11)	$t_{\text{d}(\text{ST OL4})}$		100	520	900	μs
Status output (open drain)						
Zener limit voltage $I_{\text{ST}} = +1.6\text{ mA}$:	$V_{\text{ST}(\text{high})}$		5.4	6.1	--	V
ST low voltage $I_{\text{ST}} = +1.6\text{ mA}$:	$V_{\text{ST}(\text{low})}$		--	--	0.4	V

¹⁰⁾ Integrated protection functions are designed to prevent IC destruction under fault conditions described in the data sheet. Fault conditions are considered as "outside" normal operating range. Protection functions are not designed for continuous repetitive operation.

¹¹⁾ Device on 50mm*50mm*1.5mm epoxy PCB FR4 with 6cm² (one layer, 70 μm thick) copper area for V_{bb} connection. PCB is vertical without blown air.

¹²⁾ Requires 150 Ω resistor in GND connection. The reverse load current through the intrinsic drain-source diode has to be limited by the connected load. Note that the power dissipation is higher compared to normal operating conditions due to the voltage drop across the intrinsic drain-source diode. The temperature protection is not active during reverse current operation! Input and Status currents have to be limited (see max. ratings page 3 and circuit page 7).

¹³⁾ not subject to production test, specified by design

¹⁴⁾ If a ground resistor R_{GND} is used, add the voltage drop across this resistor.

Truth Table

	Input level	Output level	Status BTS 436L2
Normal operation	L	L	H
	H	H	H
Open load	L	Z	H
	H	H	L
Overtem-perature	L	L	H
	H	L	L

L = "Low" Level
H = "High" Level

X = don't care

Z = high impedance, potential depends on external circuit
Status signal after the time delay shown in the diagrams (see fig 5. page 11)

Terms

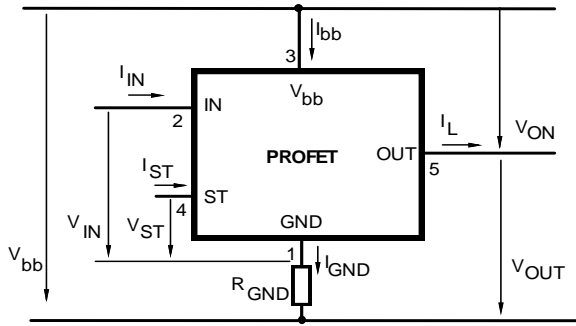

Input circuit (ESD protection)

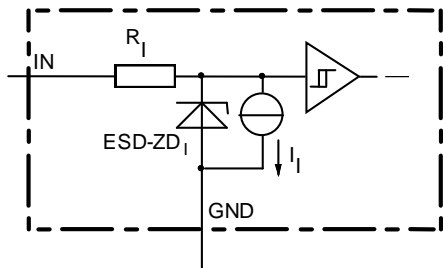

The use of ESD zener diodes as voltage clamp at DC conditions is not recommended

Status output

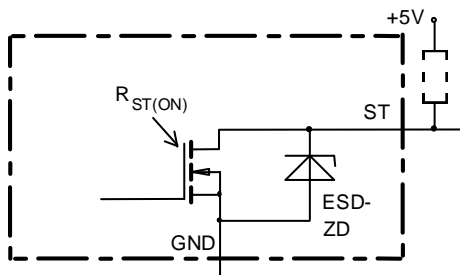

ESD-Zener diode: 6.1 V typ., max 5.0 mA; $R_{ST(ON)} < 375 \Omega$ at 1.6 mA. The use of ESD zener diodes as voltage clamp at DC conditions is not recommended.

Inductive and overvoltage output clamp

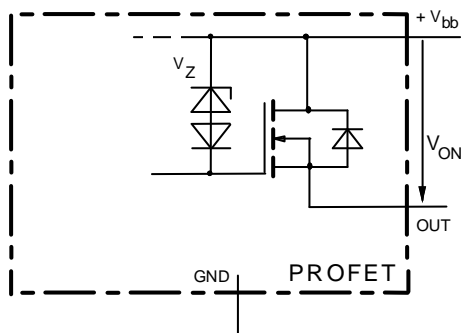

V_{ON} clamped to 47 V typ.

Overvolt. and reverse batt. protection

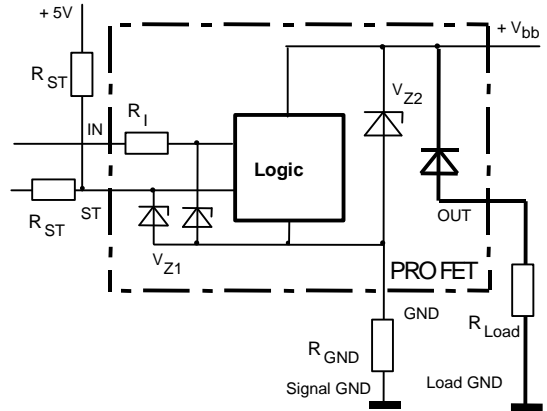

$V_{Z1} = 6.1 \text{ V typ.}$, $V_{Z2} = 47 \text{ V typ.}$, $R_{GND} = 150 \Omega$, $R_{ST} = 15 \text{ k}\Omega$, $R_I = 3.5 \text{ k}\Omega \text{ typ.}$

In case of reverse battery the load current has to be limited by the load. Temperature protection is not active

Open-load detection in on-state

Open load, if $V_{ON} < R_{ON} \cdot I_{L(OL)}$; IN high

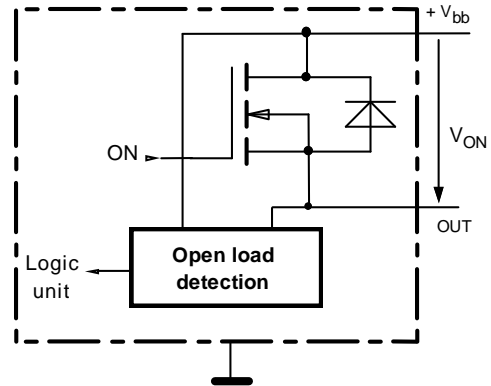

GND disconnect

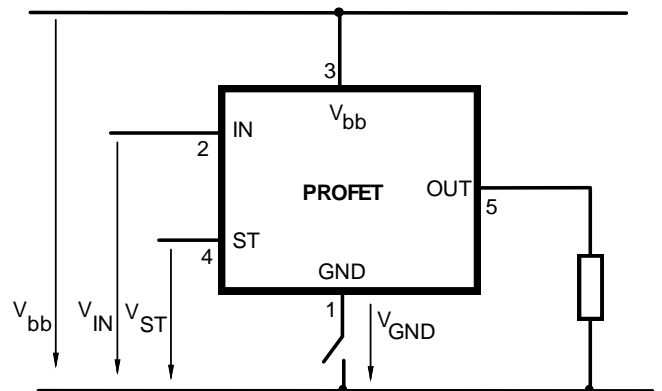

Any kind of load. In case of Input=high is $V_{OUT} \approx V_{IN} - V_{IN(T+)}$. Due to $V_{GND} > 0$, no $V_{ST} = \text{low signal}$ available.

GND disconnect with GND pull up

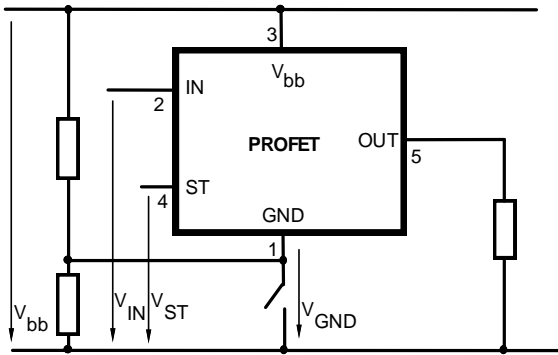

Any kind of load. If $V_{GND} > V_{IN} - V_{IN(T+)}$ device stays off
 Due to $V_{GND} > 0$, no $V_{ST} = \text{low signal}$ available.

Vbb disconnect with energized inductive load

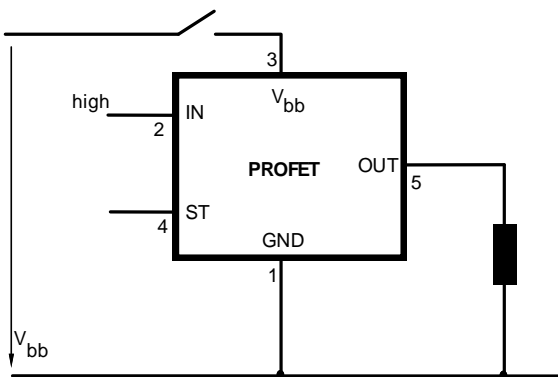

For inductive load currents up to the limits defined by Z_L (max. ratings and diagram on page 8) each switch is protected against loss of V_{bb} .

Consider at your PCB layout that in the case of V_{bb} disconnection with energized inductive load all the load current flows through the GND connection.

Inductive Load switch-off energy dissipation

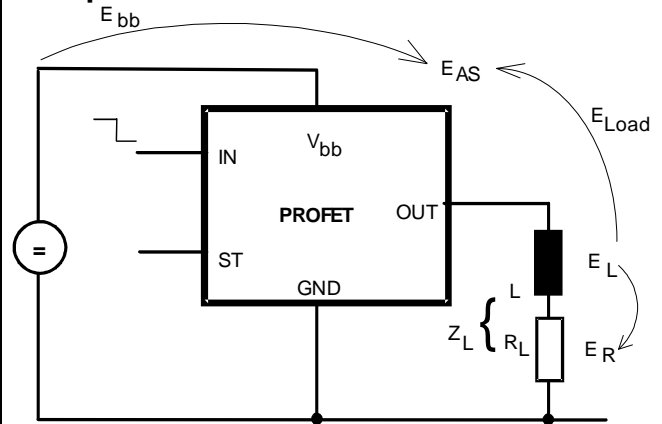

Energy stored in load inductance:

$$E_L = 1/2 \cdot L \cdot I_L^2$$

While demagnetizing load inductance, the energy dissipated in PROFET is

$$E_{AS} = E_{bb} + E_L - E_R = \int V_{ON(CL)} \cdot i_L(t) dt,$$

with an approximate solution for $R_L > 0 \Omega$:

$$E_{AS} = \frac{I_L \cdot L}{2 \cdot R_L} \cdot (V_{bb} + |V_{OUT(CL)}|) \cdot \ln \left(1 + \frac{I_L \cdot R_L}{|V_{OUT(CL)}|} \right)$$

Maximum allowable load inductance for a single switch off

$L = f(I_L)$; $T_{j,start} = 150^\circ C$, $T_C = 150^\circ C$ const.,
 $V_{bb} = 12 V$, $R_L = 0 \Omega$

Z_L [mH]

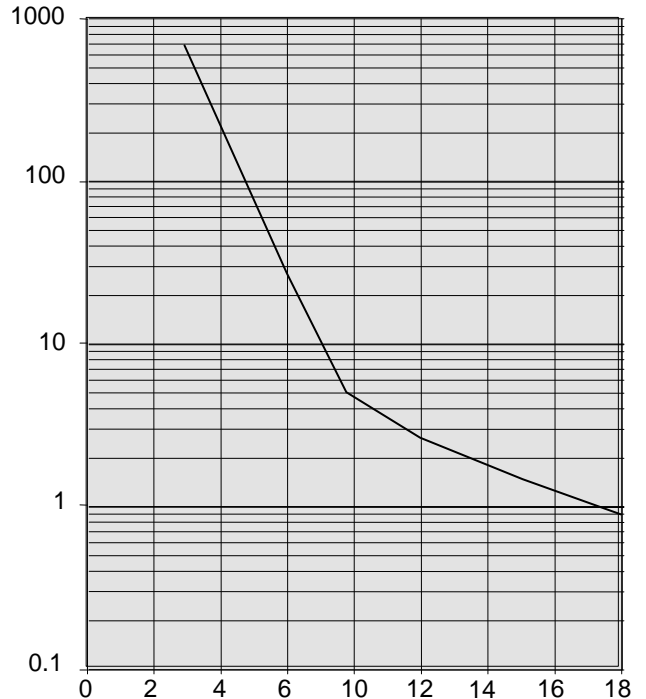

I_L [A]

Typ. on-state resistance

$R_{ON} = f(V_{bb}, T_j); I_L = 2\text{ A}, I_N = \text{high}$

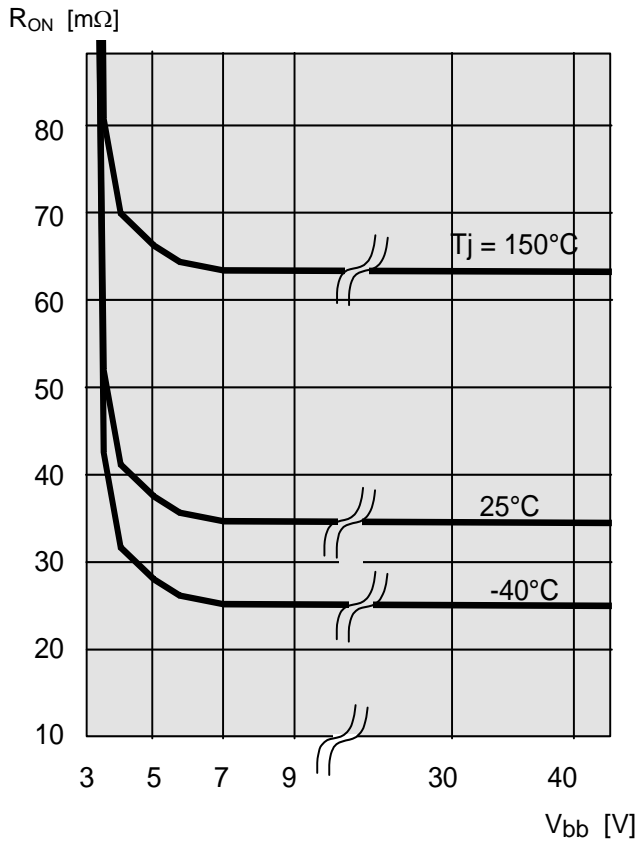

Typ. standby current

$I_{bb(off)} = f(T_j); V_{bb} = 9\text{...}34\text{ V}, I_{N1,2} = \text{low}$

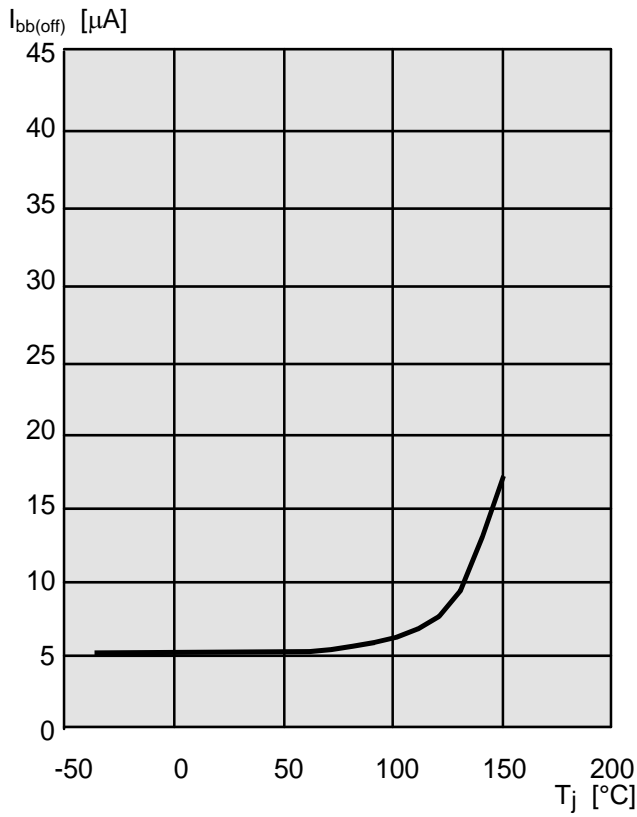

Timing diagrams

Figure 1a: V_{bb} turn on:

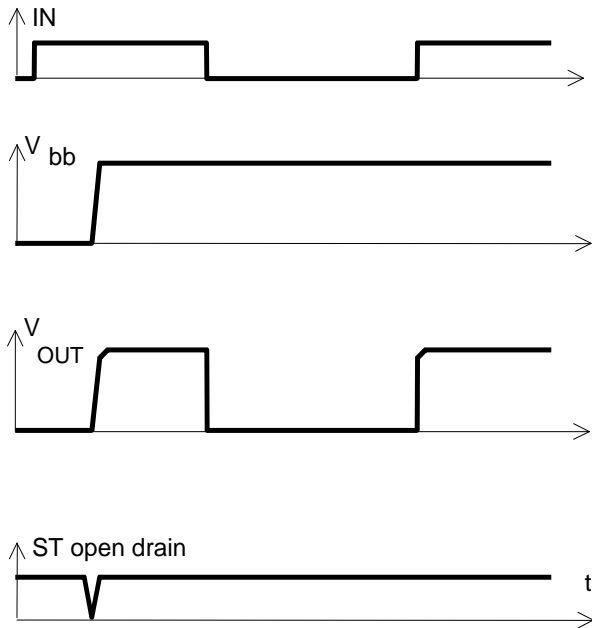

proper turn on under all conditions

Figure 2a: Switching a resistive load, turn-on/off time and slew rate definition:

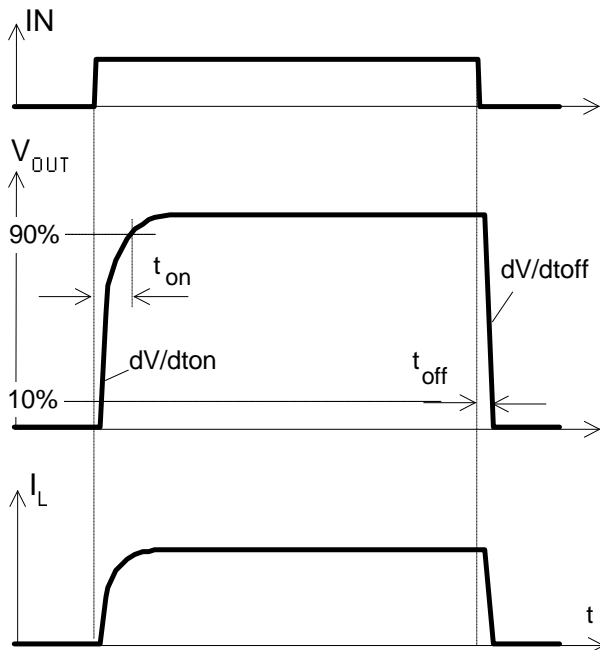
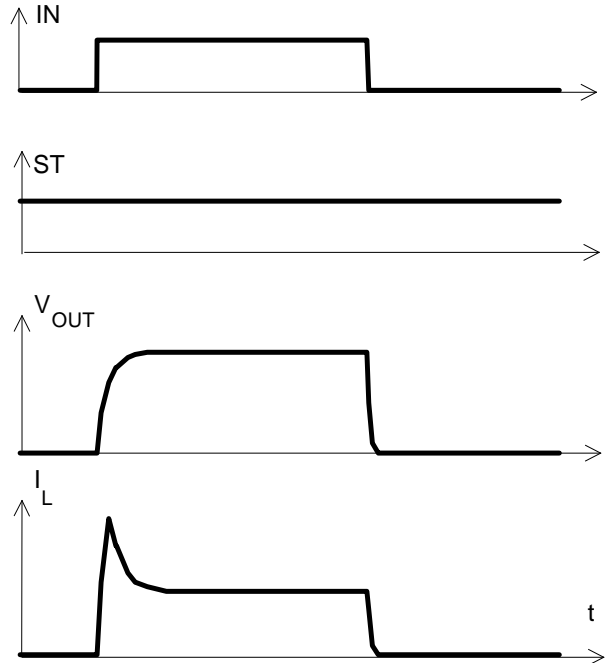
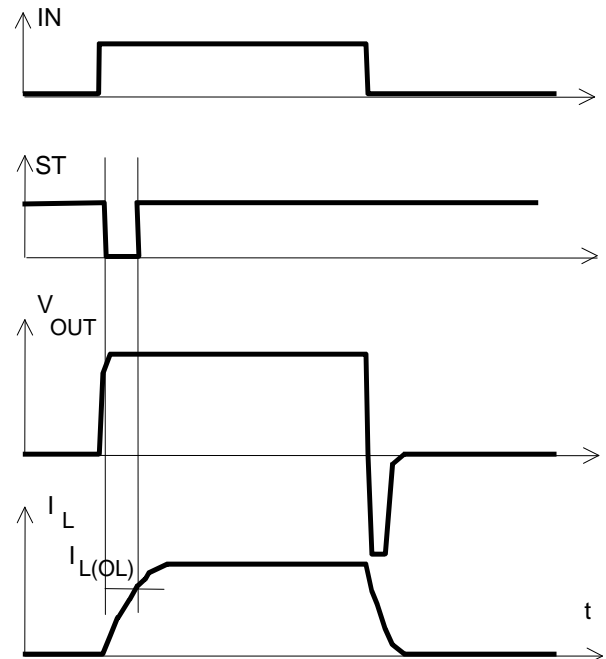

Figure 2b: Switching a lamp,



The initial peak current should be limited by the lamp and not by the current limit of the device.

Figure 2c: Switching an inductive load



*) if the time constant of load is too large, open-load-status may occur

Figure 3a: Short circuit shut down by overtemperature, reset by cooling

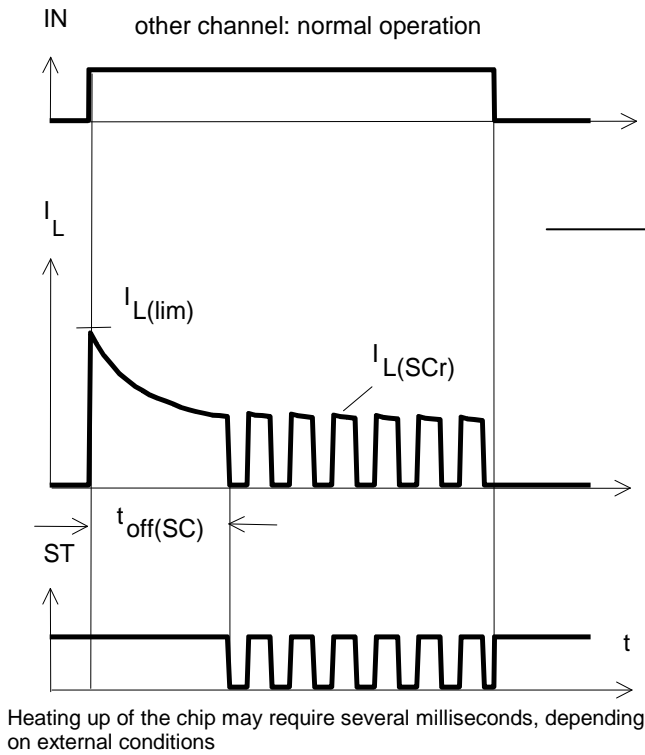

Figure 4a: Overtemperature: Reset if $T_j < T_{jt}$

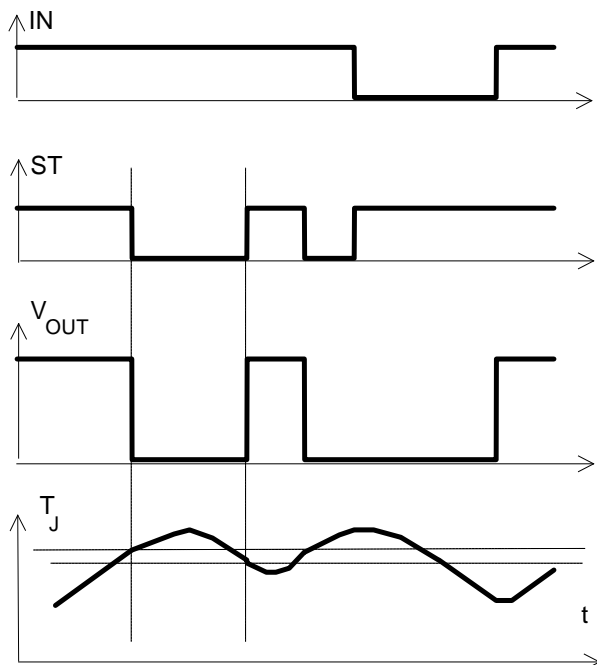

Figure 5a: Open load: detection in ON-state, open load occurs in on-state

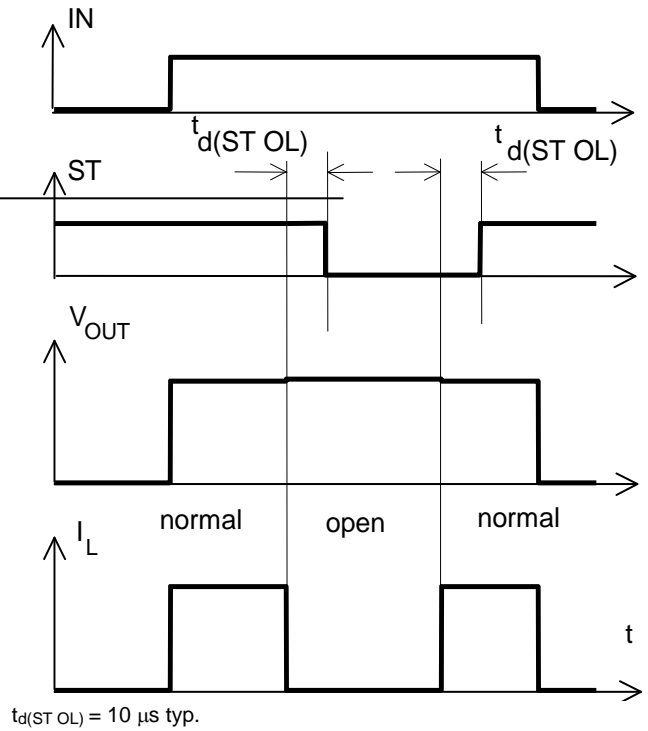
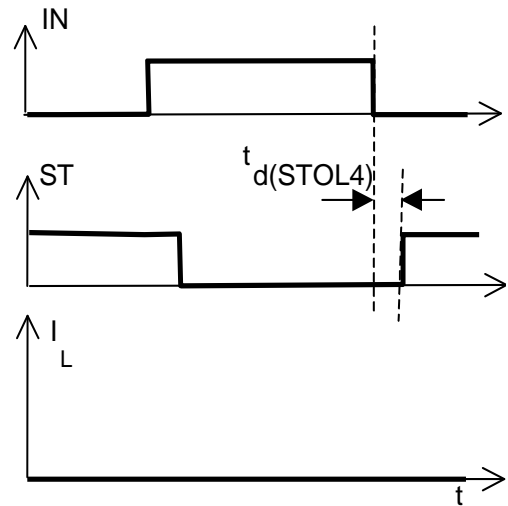

Figure 5b: Open load: turn on/off to open load



Package and Ordering Code

All dimensions in mm

PG-TO263-5-2

Sales code	BTS436L2G
Ordering code:	SP001104828

Published by
Infineon Technologies AG,
 D-81726 München
 © Infineon Technologies AG 2013
All Rights Reserved.

Attention please!

The information herein is given to describe certain components and shall not be considered as a guarantee of characteristics.

Terms of delivery and rights to technical change reserved.

We hereby disclaim any and all warranties, including but not limited to warranties of non-infringement, regarding circuits, descriptions and charts stated herein.

Infineon Technologies is an approved CECC manufacturer.

Information

For further information on technology, delivery terms and conditions and prices please contact your nearest Infineon Technologies Office in Germany or our Infineon Technologies Representatives worldwide (see address list).

Warnings

Due to technical requirements components may contain dangerous substances. For information on the types in question please contact your nearest Infineon Technologies Office.

Infineon Technologies Components may only be used in life-support devices or systems with the express written approval of Infineon Technologies, if a failure of such components can reasonably be expected to cause the failure of that life-support device or system, or to affect the safety or effectiveness of that device or system. Life support devices or systems are intended to be implanted in the human body, or to support and/or maintain and sustain and/or protect human life. If they fail, it is reasonable to assume that the health of the user or other persons may be endangered.

