

High Power RF LDMOS Field Effect Transistor 12 W, 28 V, 700 – 2200 MHz

Description

The PTFA220121M is an unmatched 12-watt LDMOS FET intended for power amplifier applications in the 700 to 2200 MHz. This LDMOS device offers excellent gain, efficiency and linearity performance in a small overmolded plastic package.

PTFA220121M
Package PG-SON-10

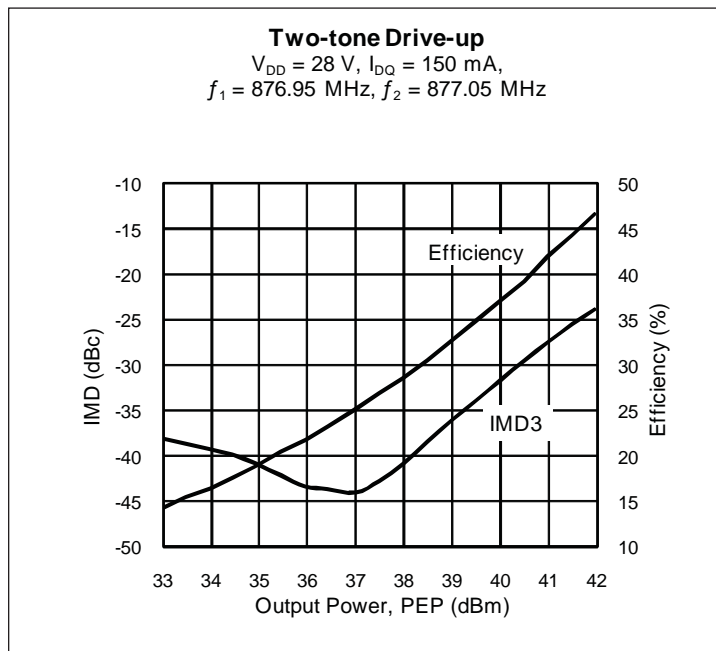

Features

- Typical two-carrier WCDMA performance at 2140 MHz, 8 dB PAR
 - $P_{OUT} = 33\text{ dBm Avg}$
 - ACPR = -45.5 dBc
- Typical two-carrier WCDMA performance at 877 MHz, 8 dB PAR
 - $P_{OUT} = 33\text{ dBm Avg}$
 - ACPR = -44.5 dBc
- Typical CW performance, 2140 MHz, 28 V
 - $P_{OUT} = 41.6\text{ dBm}$
 - Efficiency = 53.5%
 - Gain = 15.5 dB
- Typical CW performance, 877 MHz, 28 V
 - $P_{OUT} = 41.8\text{ dBm}$
 - Efficiency = 60%
 - Gain = 19.9 dB
- Capable of handling 10:1 VSWR @ 28 V, 12 W (CW) output power
- Integrated ESD protection
- Excellent thermal stability
- Pb-free and RoHS compliant

RF Characteristics

Two-tone Measurements (not subject to production test – verified by design / characterization in Infineon test fixture)
 $V_{DD} = 28\text{ V}$, $I_{DQ} = 150\text{ mA}$, $P_{OUT} = 12\text{ W PEP}$, $f = 877\text{ MHz}$, tone spacing = 1 MHz

Characteristic	Symbol	Min	Typ	Max	Unit
Gain	G_{ps}	20	20.5	—	dB
Drain Efficiency	η_D	41	42.5	—	%
Intermodulation Distortion	IMD	—	-33	-32	dBc

All published data at $T_{CASE} = 25^\circ\text{C}$ unless otherwise indicated

ESD: Electrostatic discharge sensitive device—observe handling precautions!

RF Characteristics (cont.)

Two-tone Measurements (not subject to production test – verified by design / characterization in Infineon test fixture)
 $V_{DD} = 28\text{ V}$, $I_{DQ} = 150\text{ mA}$, $P_{OUT} = 9.3\text{ W PEP}$, $f = 2140\text{ MHz}$, tone spacing = 1 MHz

Characteristic	Symbol	Min	Typ	Max	Unit
Gain	G_{ps}	—	16.2	—	dB
Drain Efficiency	η_D	—	37	—	%
Intermodulation Distortion	IMD	—	-29.4	—	dBc

DC Characteristics

Characteristic	Conditions	Symbol	Min	Typ	Max	Unit
Drain-Source Breakdown Voltage	$V_{GS} = 0\text{ V}$, $I_{DS} = 10\text{ }\mu\text{A}$	$V_{(BR)DSS}$	65	—	—	V
Drain Leakage Current	$V_{DS} = 28\text{ V}$, $V_{GS} = 0\text{ V}$	I_{DSS}	—	—	1.0	μA
On-State Resistance	$V_{GS} = 10\text{ V}$, $V_{DS} = 0.1\text{ A}$	$R_{DS(on)}$	—	2.01	—	Ω
Operating Gate Voltage	$V_{DS} = 28\text{ V}$, $I_{DQ} = 150\text{ mA}$	V_{GS}	2.0	2.5	3.0	V
Gate Leakage Current	$V_{GS} = 10\text{ V}$, $V_{DS} = 0\text{ V}$	I_{GSS}	—	—	1.0	μA

Maximum Ratings

Parameter	Symbol	Value	Unit
Drain-Source Voltage	V_{DSS}	65	V
Gate-Source Voltage	V_{GS}	-0.5 to +12	V
Junction Temperature	T_J	175	$^{\circ}\text{C}$
Storage Temperature Range	T_{STG}	-40 to +150	$^{\circ}\text{C}$
Thermal Resistance ($T_{CASE} = 70^{\circ}\text{C}$, 12 W CW)	$R_{\theta JC}$	3.4	$^{\circ}\text{C/W}$

Moisture Sensitivity Level

Level	Test Standard	Package Temperature	Unit
3	IPC/JEDEC J-STD-020	260	$^{\circ}\text{C}$

Ordering Information

Type and Version	Order Code	Package and Description	Shipping
PTFA220121M V4 R1K	PTFA220121MV4R1KV4XUMA1	PG-SON-10, Molded plastic, SMD	Tape & Reel, 1,000 pcs

Typical Performance, 877 MHz (data taken in a production test fixture)

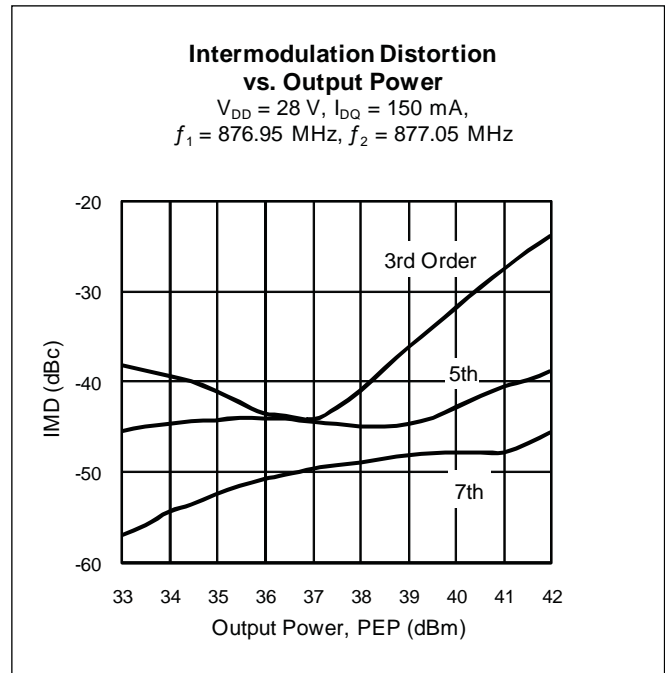
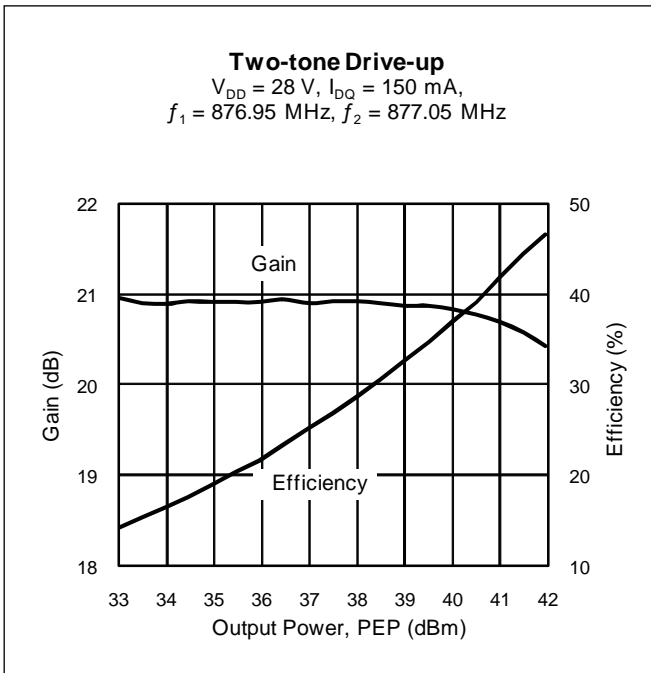
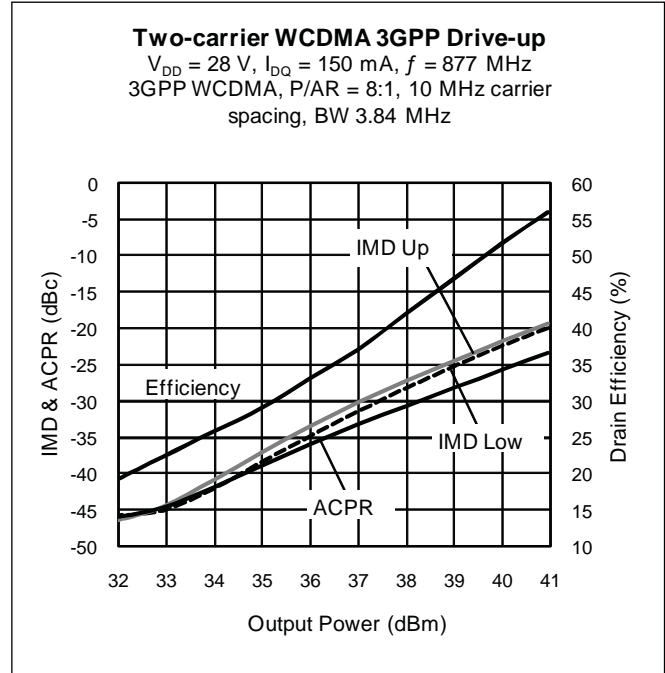
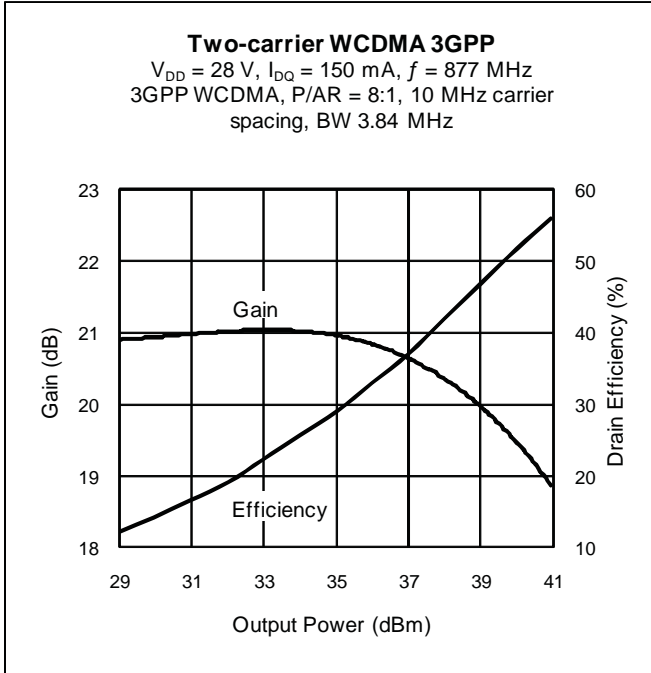

Typical Performance, 877 MHz (cont.)

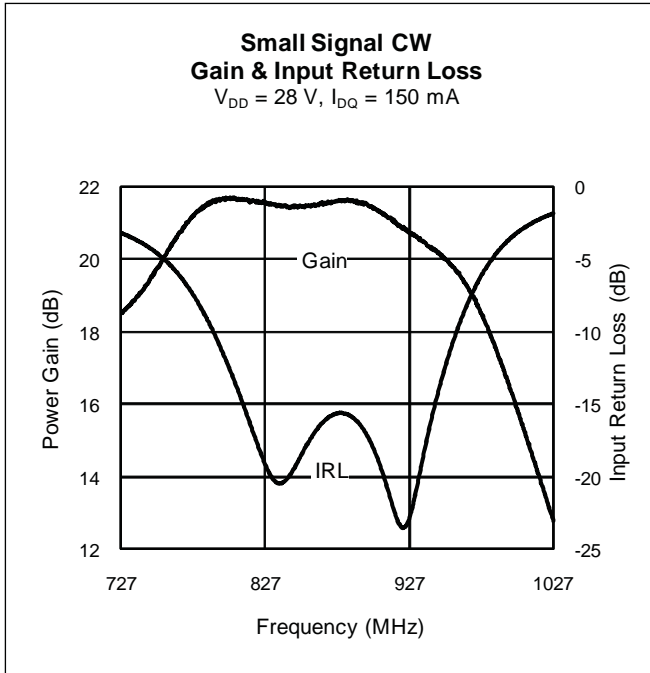

Broadband Circuit Impedance

Frequency MHz	Z Source Ω		Z Load Ω	
	R	jX	R	jX
720	1.1	7.7	12.0	4.8
820	1.0	6.4	12.4	4.0
869	1.3	5.0	10.8	5.9
894	1.2	3.6	9.3	6.7
920	1.4	3.5	9.1	6.7
940	1.5	3.3	9.1	6.9
960	1.4	2.8	8.9	6.3
1675	1.6	0.3	5.0	5.3
1805	2.0	0.3	4.7	3.2
1880	2.0	0.3	4.7	2.9
1930	2.2	-0.9	4.2	3.0
1990	2.6	-2.0	3.8	1.8
2110	2.5	-3.1	3.8	1.8
2170	2.0	-2.6	3.6	1.9
2300	1.7	-1.7	3.3	1.6
2400	2.2	-2.5	3.2	0.5
2500	2.5	-4.5	3.0	0.5
2600	2.4	-4.1	2.7	1.2
2700	1.9	-3.1	2.3	1.4

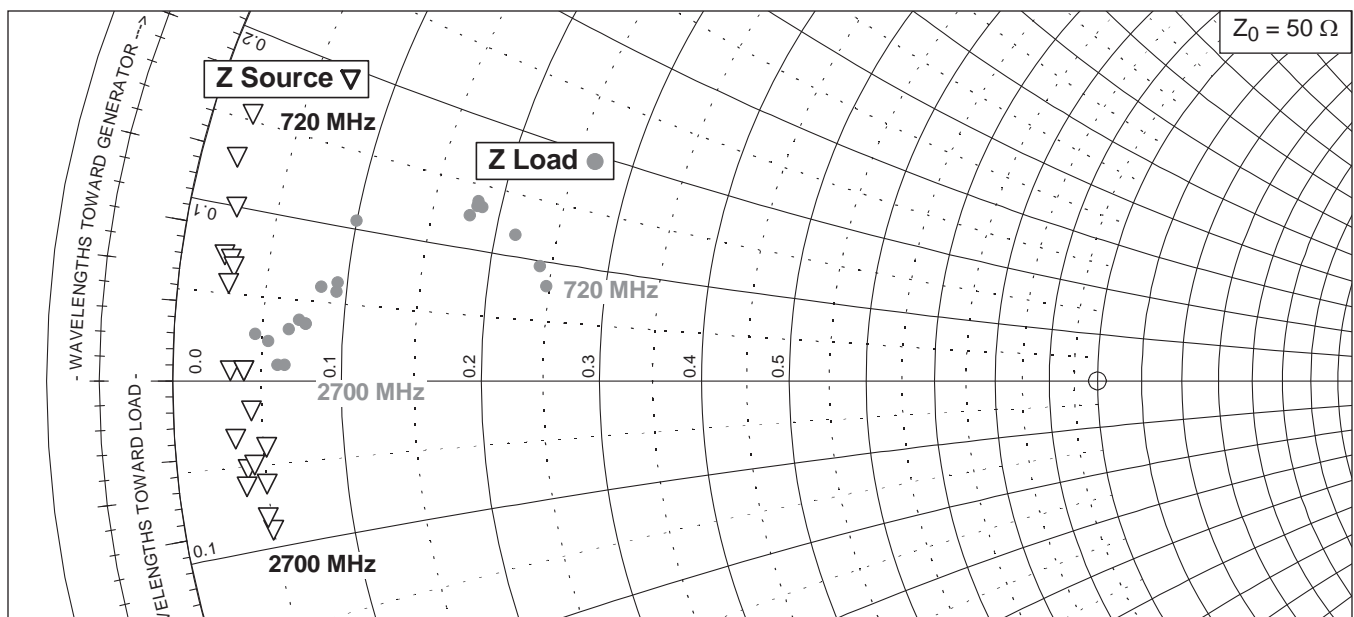
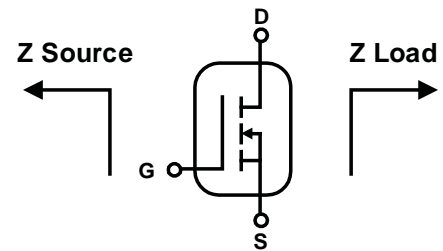

Reference Circuit, 877 MHz

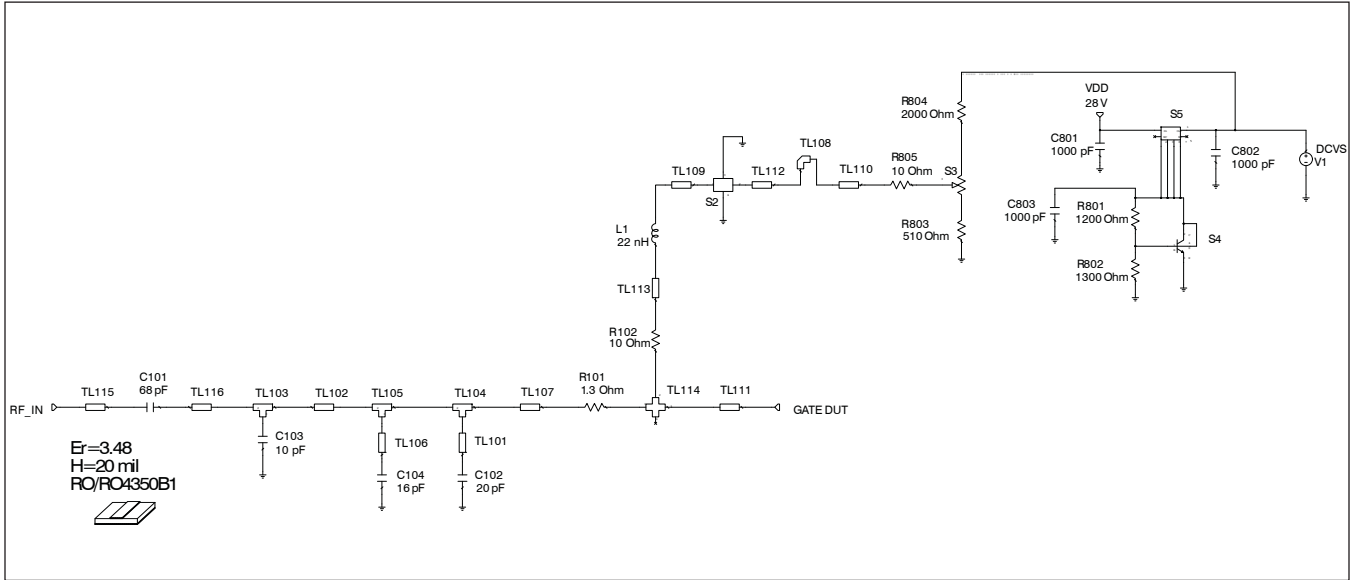

Reference circuit input schematic for $f = 877$ MHz

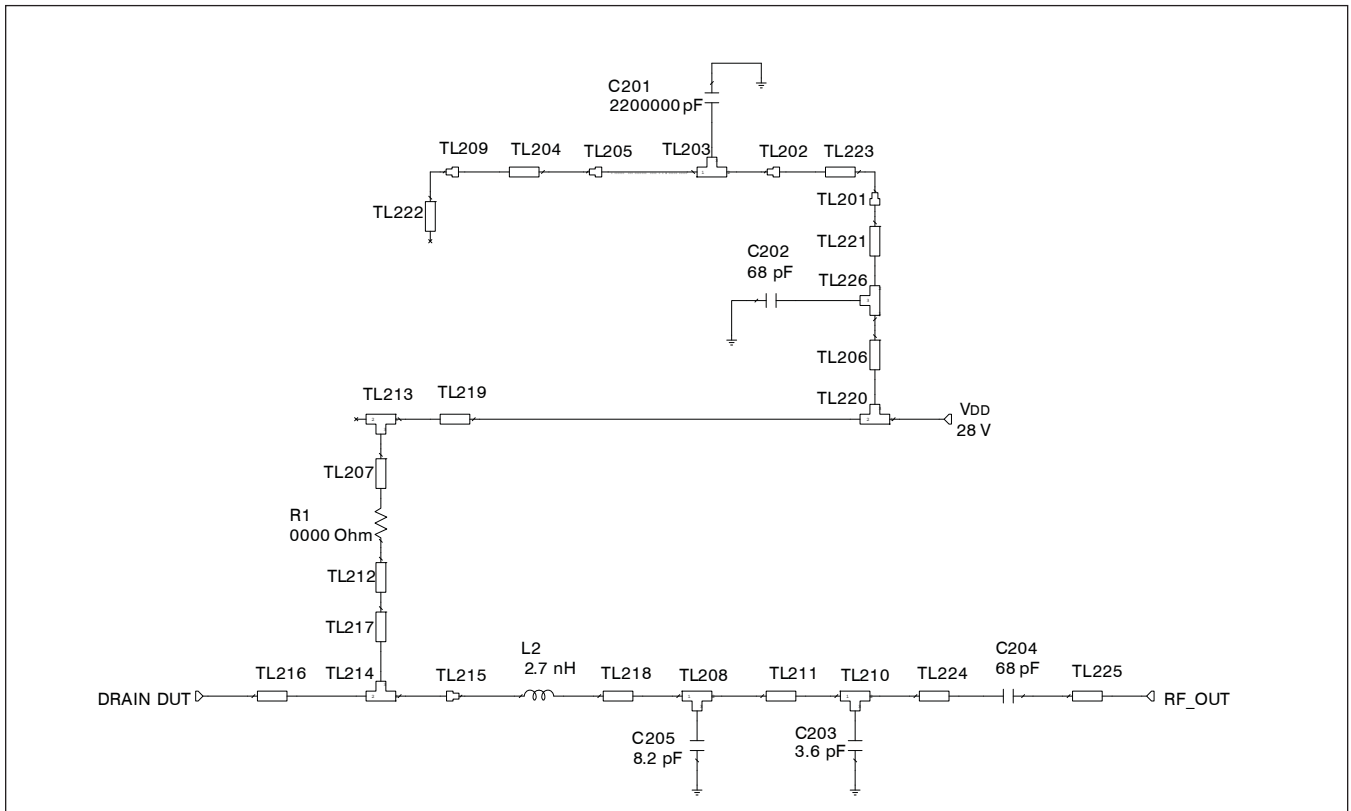

Reference circuit output schematic for $f = 877$ MHz

Reference Circuit, 877 MHz (cont.)
Description

DUT	PTFA220121M
PCB	0.508 mm [.020"] thick, $\epsilon_r = 3.48$, Rogers 4350, 1 oz. copper

Electrical Characteristics at 877 MHz

Transmission Line	Electrical Characteristics	Dimensions: mm	Dimensions: mils
Input			
TL101, TL106		W = 0.000, L = 0.000	W = 0, L = 0
TL102	0.050 λ , 51.98 Ω	W = 1.087, L = 10.262	W = 43, L = 404
TL103, TL104, TL105	0.004 λ , 51.98 Ω	W1 = 1.087, W2 = 1.087, W3 = 0.813	W1 = 43, W2 = 43, W3 = 32
TL107	0.004 λ , 51.98 Ω	W = 1.087, L = 0.813	W = 43, L = 32
TL108		W = 1.524	W = 60
TL109	0.007 λ , 54.17 Ω	W = 1.016, L = 1.524	W = 40, L = 60
TL110	0.025 λ , 41.75 Ω	W = 1.524, L = 5.080	W = 60, L = 200
TL111	0.009 λ , 25.04 Ω	W = 3.048, L = 1.778	W = 120, L = 70
TL112	0.002 λ , 41.75 Ω	W = 1.524, L = 0.508	W = 60, L = 20
TL113	0.006 λ , 41.75 Ω	W = 1.524, L = 1.270	W = 60, L = 50
TL114		1W1 = 3.048, W2 = 0.762, W3 = 3.048, W4 = 0.762	W1 = 120, W2 = 30, W3 = 120, W4 = 30
TL115	0.016 λ , 51.98 Ω	W = 1.087, L = 3.264	W = 43, L = 129
TL116	0.044 λ , 51.98 Ω	W = 1.087, L = 9.093	W = 43, L = 358

table continued on page 8

Reference Circuit, 877 MHz (cont.)
Electrical Characteristics at 877 MHz

Transmission Line	Electrical Characteristics	Dimensions: mm	Dimensions: mils
Output			
TL201		W1 = 1.270, W2 = 5.283, Offset = -2.007	W1 = 50, W2 = 208, Offset = -79
TL202		W1 = 5.283, W2 = 5.283, Offset = 0.000	W1 = 208, W2 = 208, Offset = 0
TL203	0.016 λ , 15.92 Ω	W1 = 5.283, W2 = 5.283, W3 = 3.023	W1 = 208, W2 = 208, W3 = 119
TL204	0.007 λ , 4.80 Ω	W = 19.850, L = 1.270	W = 782, L = 50
TL205		W1 = 19.812, W2 = 19.812, Offset = 7.264	W1 = 780, W2 = 780, Offset = 286
TL206	0.066 λ , 47.12 W	W = 1.270, L = 13.467	W = 50, L = 530
TL207	0.002 λ , 41.75 Ω	W = 1.524, L = 0.508	W = 60, L = 20
TL208, TL210	0.004 λ , 51.98 Ω	W1 = 1.087, W2 = 1.087, W3 = 0.813	W1 = 43, W2 = 43, W3 = 32
TL209		W1 = 1.270, W2 = 1.270, Offset = 10.566	W1 = 50, W2 = 50, Offset = 416
TL211	0.089 λ , 51.98 Ω	W = 1.087, L = 18.313	W = 43, L = 721
TL212	0.007 λ , 41.75 Ω	W = 1.524, L = 1.524	W = 60, L = 60
TL213	0.007 λ , 41.75 Ω	W1 = 1.524, W2 = 1.524, W3 = 1.524	W1 = 60, W2 = 60, W3 = 60
TL214	0.004 λ , 25.04 Ω	W1 = 3.048, W2 = 3.048, W3 = 0.762	W1 = 120, W2 = 120, W3 = 30
TL215		W1 = 1.087, W2 = 3.048	W1 = 43, W2 = 120
TL216	0.009 λ , 25.04 Ω	W = 3.048, L = 1.778	W = 120, L = 70
TL217	0.006 λ , 63.89 Ω	W = 0.762, L = 1.270	W = 30, L = 50
TL218	0.002 λ , 51.98 Ω	W = 1.087, L = 0.356	W = 43, L = 14
TL219	0.040 λ , 41.75 Ω	W = 1.524, L = 8.204	W = 60, L = 323
TL220	0.006 λ , 41.75 Ω	W1 = 1.524, W2 = 1.524, W3 = 1.270	W1 = 60, W2 = 60, W3 = 50
TL221	0.006 λ , 47.12 Ω	W = 1.270, L = 1.191	W = 50, L = 47
TL222	0.035 λ , 47.12 Ω	W = 1.270, L = 7.290	W = 50, L = 287
TL223	0.014 λ , 15.92 Ω	W = 5.283, L = 2.667	W = 208, L = 105
TL224	0.012 λ , 51.98 Ω	W = 1.087, L = 2.502	W = 43, L = 99
TL225	0.016 λ , 51.98 Ω	W = 1.087, L = 3.264	W = 43, L = 129
TL226	0.006 λ , 47.12 Ω	W1 = 1.270, W2 = 1.270, W3 = 1.270	W1 = 50, W2 = 50, W3 = 50

Reference Circuit, 877 MHz (cont.)

Circuit Assembly Information

Test Fixture Part No. LTN/ PTFA220121M-8

Find Gerber files for this test fixture on the Infineon Web site at <http://www.infineon.com/rfpower>

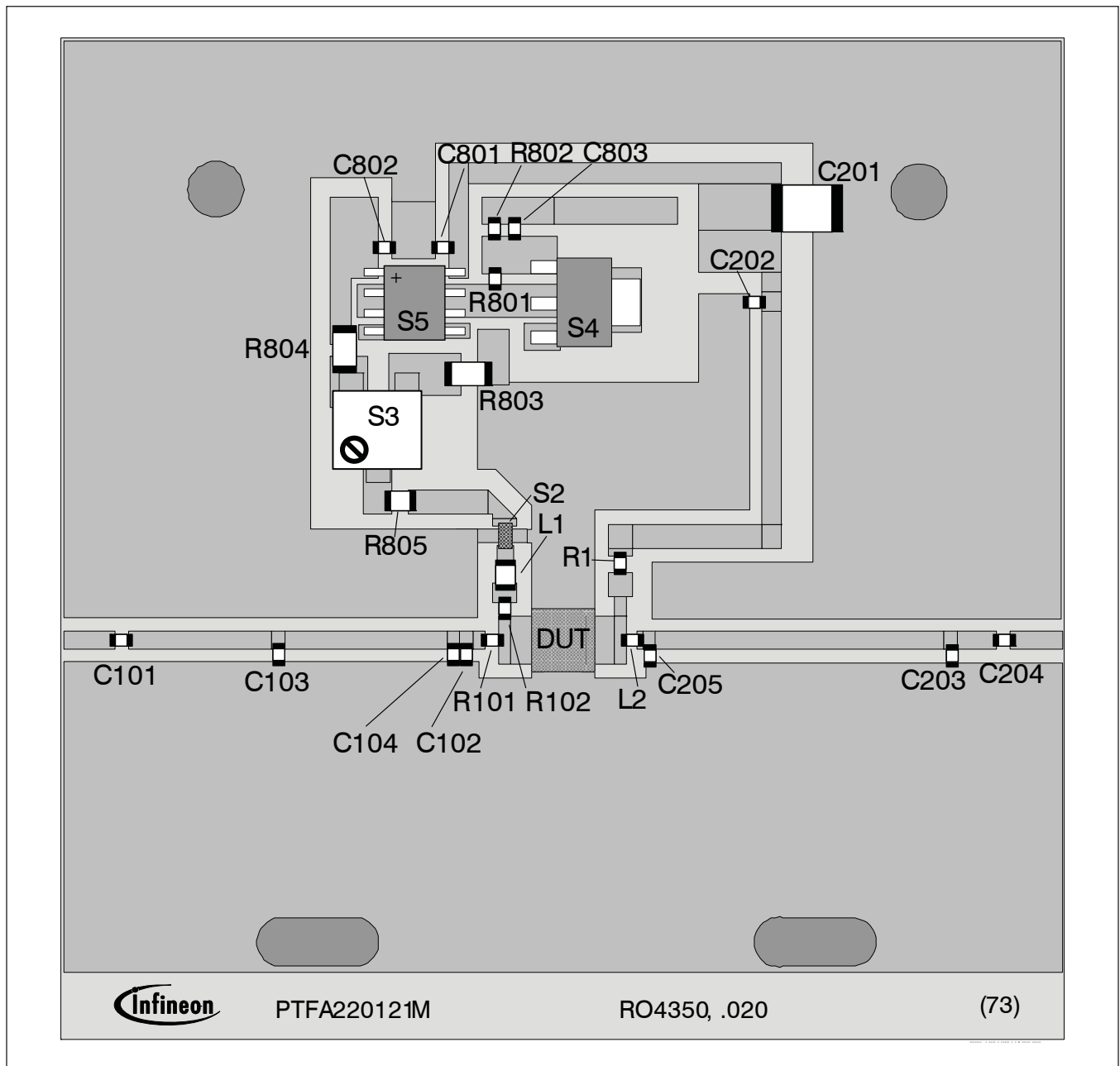

Reference circuit assembly diagram (not to scale)

Reference Circuit, 877 MHz (cont.)
Components Information

Component	Description	Manufacturer	P/N
Input			
C101	Chip capacitor, 68 pF	ATC	ATC100A680JW150X
C102	Chip capacitor, 20 pF	ATC	ATC100A200JW150X
C103	Chip capacitor, 10 pF	ATC	ATC100A100JW150X
C104	Chip capacitor, 16 pF	ATC	ATC100A160JW150X
C801, C802, C803	Chip capacitor, 1000 pF	Panasonic Electronic Components	ECJ-1VB1H102K
L1	Inductor, 22 nH	Coilcraft	0805HT-22NX_BG
R101	Resistor, 1.3 Ω	Panasonic Electronic Components	ERJ-8GEYJ1R3V
R102, R805	Resistor, 10 Ω	Panasonic Electronic Components	ERJ-8GEYJ100V
R801	Resistor, 1200 Ω	Panasonic Electronic Components	ERJ-8GEYJ122V
R802	Resistor, 1300 Ω	Panasonic Electronic Components	ERJ-8GEYJ132V
R803	Resistor, 510 Ω	Panasonic Electronic Components	ERJ-8GEYJ511V
R804	Resistor, 2000 Ω	Panasonic Electronic Components	ERJ-8GEYJ202V
S2	EMI Suppression Capacitor	Murata	NFM18PS105R0J3D
S3	Potentiometer, 2k Ω	Bourns Inc.	3224W-1-202E
S4	Transistor	Fairchild Semiconductor	BCP56
S5	Voltage regulator	Fairchild Semiconductor	LM7805
Output			
C201	Chip capacitor, 2.2 μ F	TDK Corporation	C4532X7R1H225M160KA
C202, C204	Chip capacitor, 68 pF	ATC	ATC100A680JW150X
C203	Chip capacitor, 3.6 pF	ATC	ATC100A3R6CW150X
C205	Chip capacitor, 8.2 pF	ATC	ATC100A8R2CW150X
L2	Inductor, 2.7 nH	Coilcraft	0402CS-2N7X_BG
R201	Resistor, 0.0 Ω	Panasonic Electronic Components	ERJ-8GEY0R00V

Typical Performance, 1805 MHz

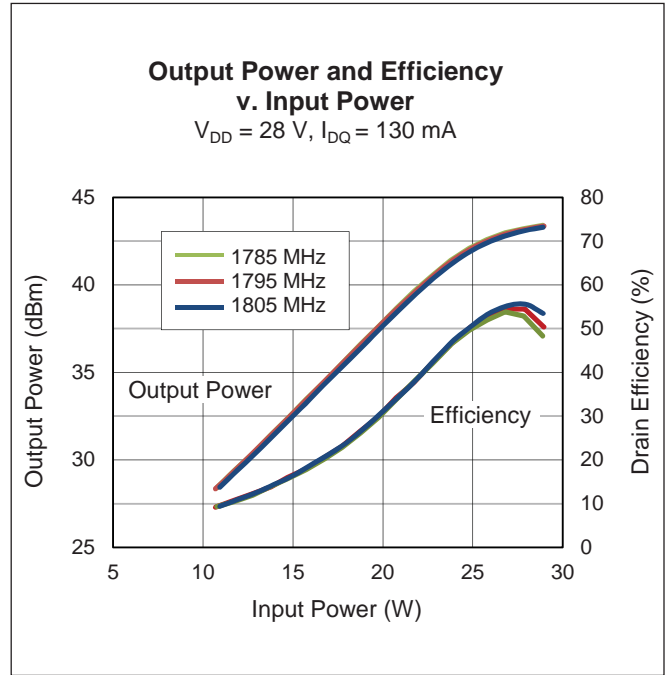
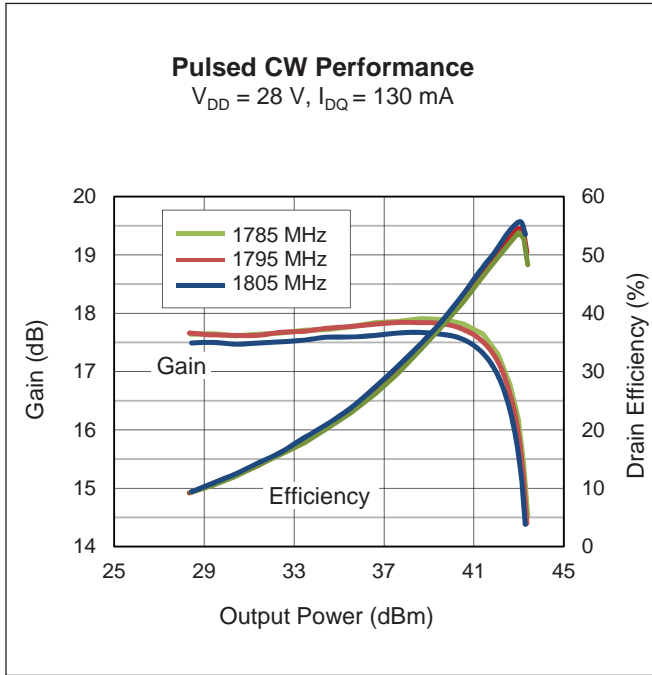

RF Characteristics

Pulsed CW Performance (not subject to production test – verified by design / characterization in Infineon test fixture)
 $V_{DD} = 28\text{ V}$, $I_{DQ} = 130\text{ mA}$, $P_{OUT} = 42\text{ W}$ P_{1dB} , $f = 1805\text{ MHz}$
 16 μs pulse width, 10% duty cycle, class AB test

Characteristic	Symbol	Min	Typ	Max	Unit
Gain	G_{ps}	—	17	—	dB
Drain Efficiency	η_D	—	52	—	%

Typical Performance, 2140 MHz

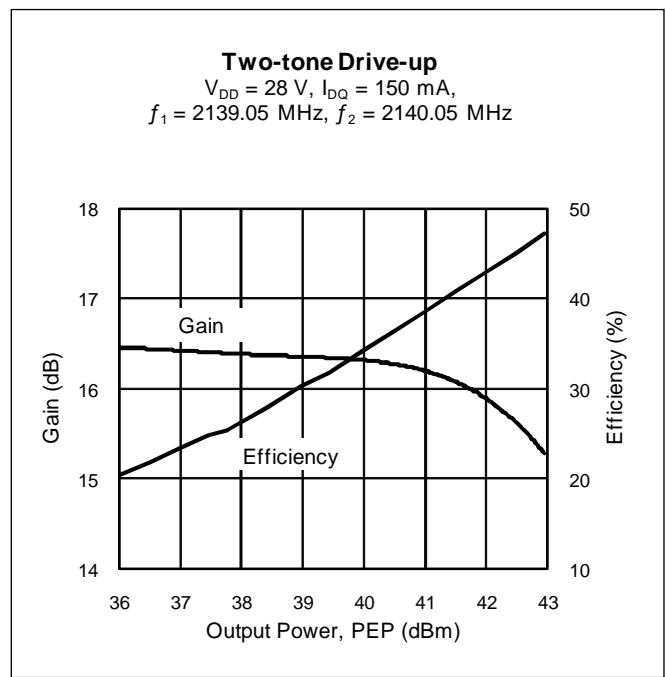
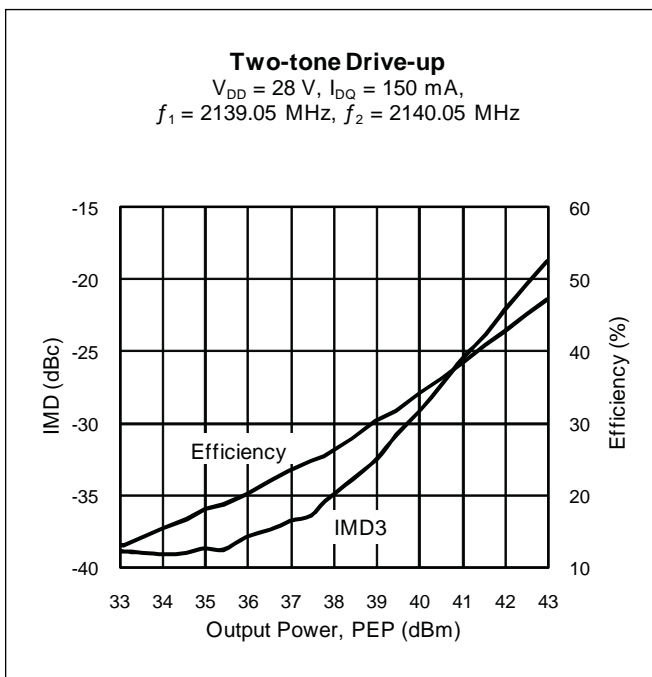
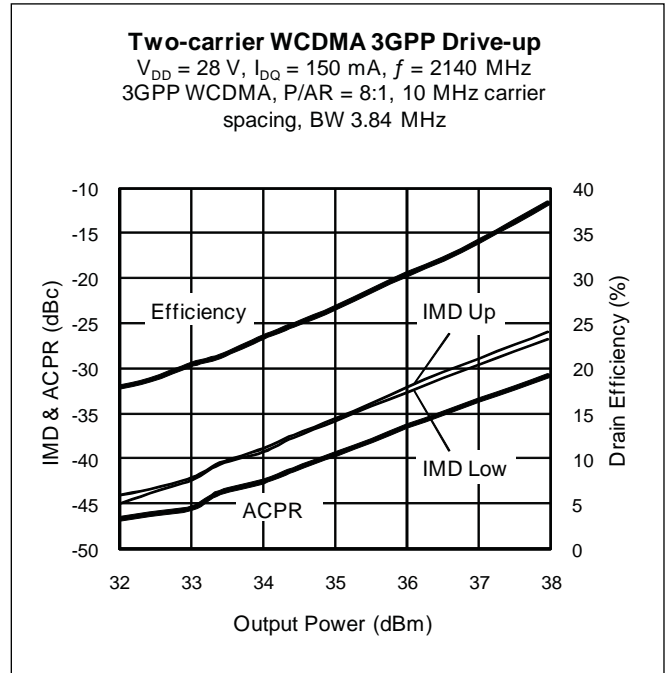
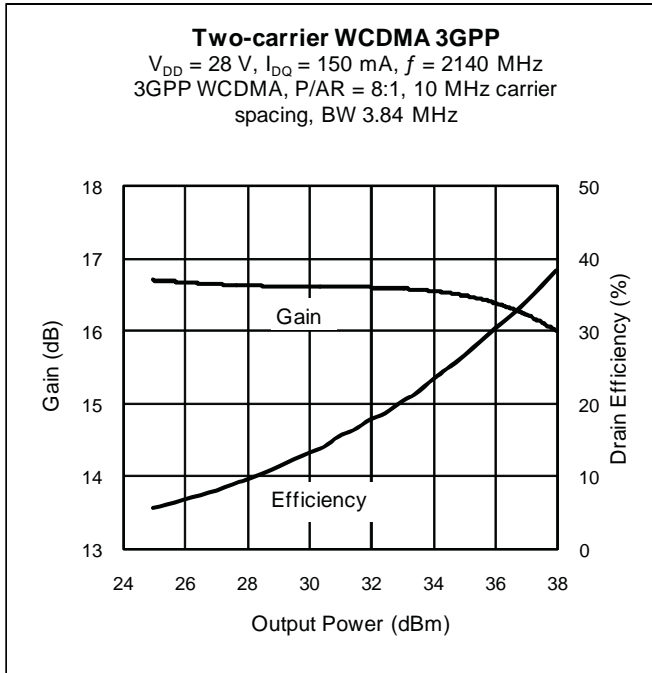

Typical Performance, 2140 MHz (cont.)

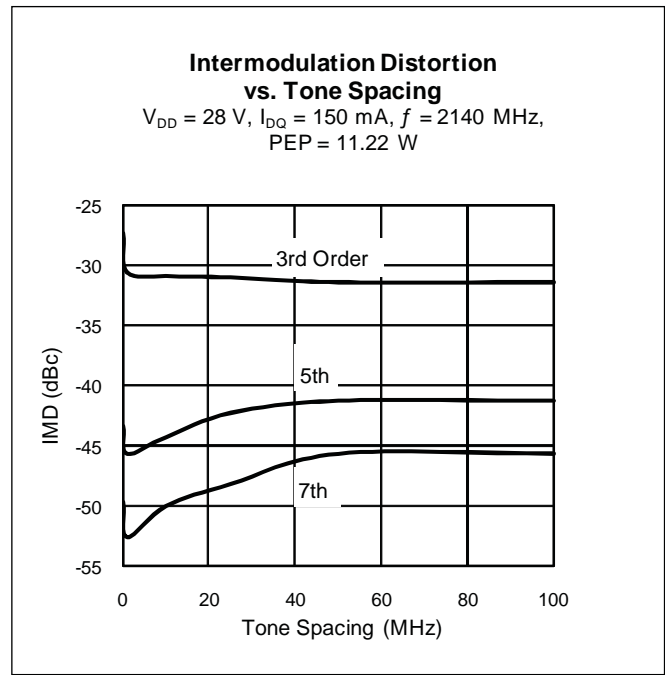
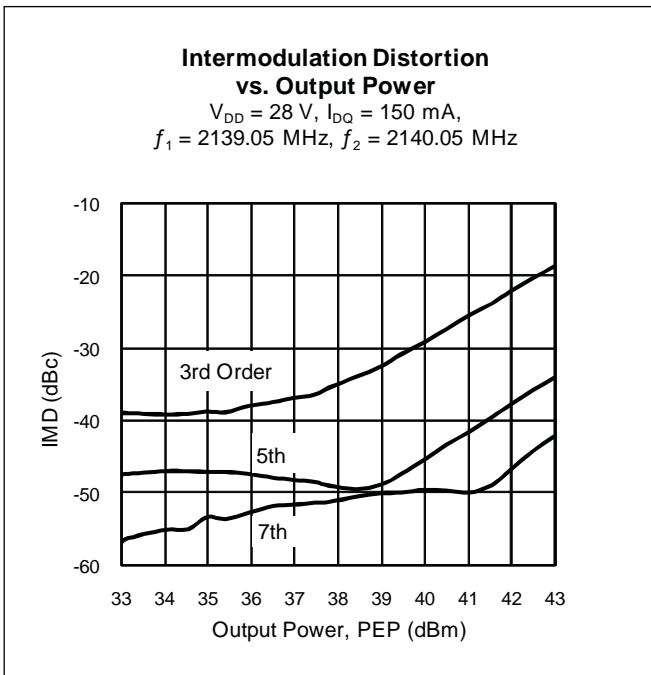
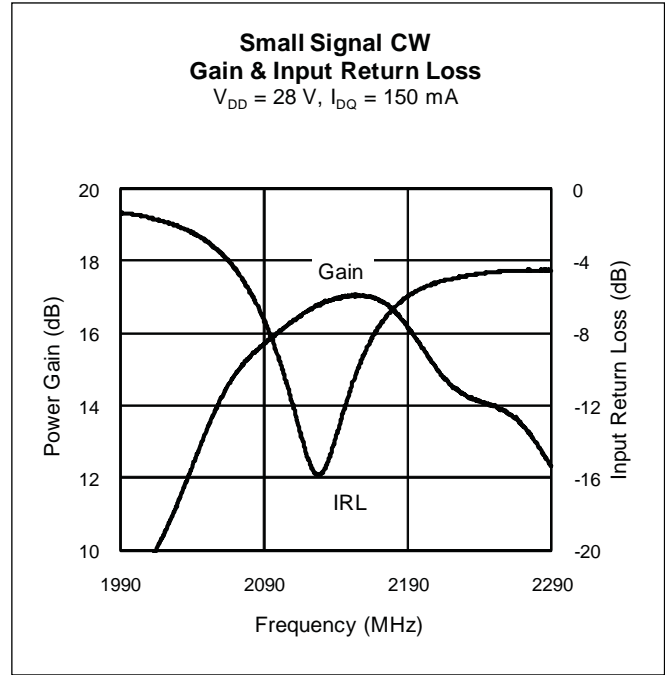
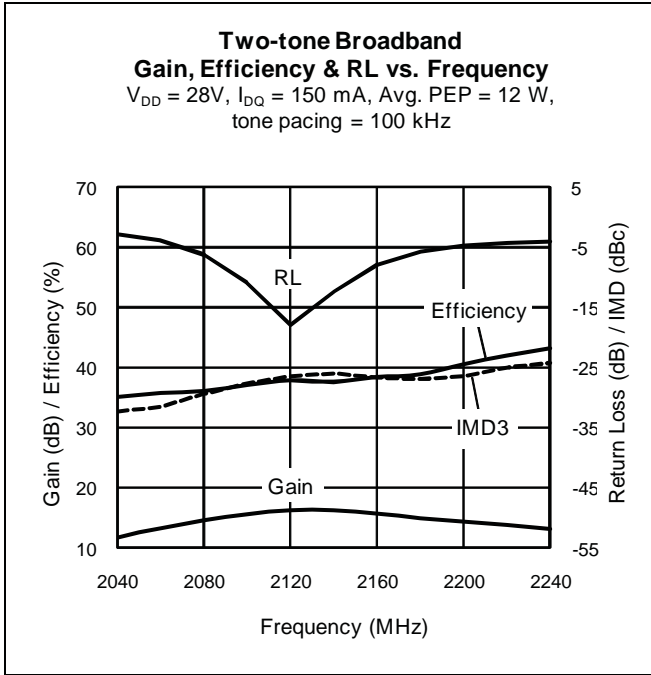

Typical Performance, 2140 MHz (cont.)

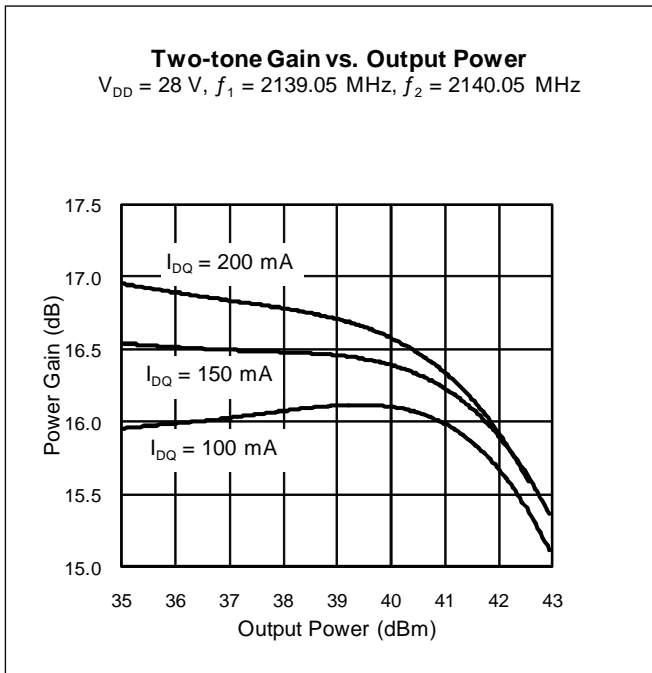
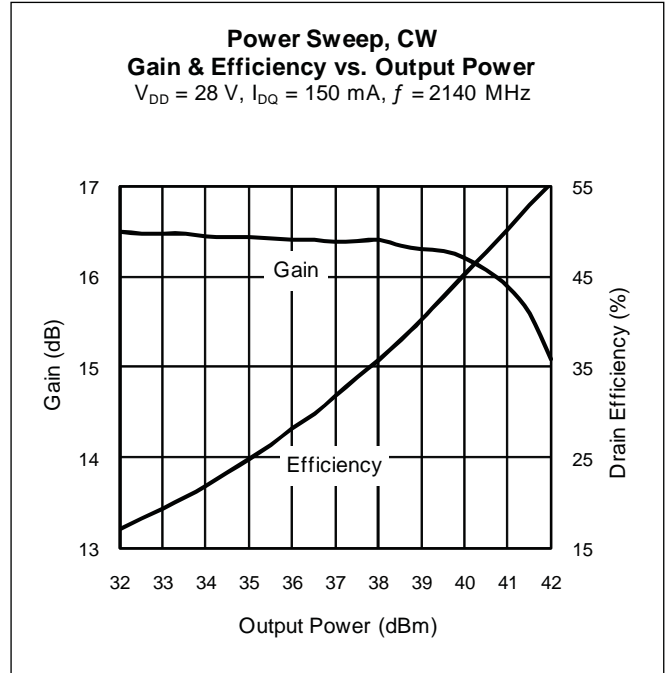
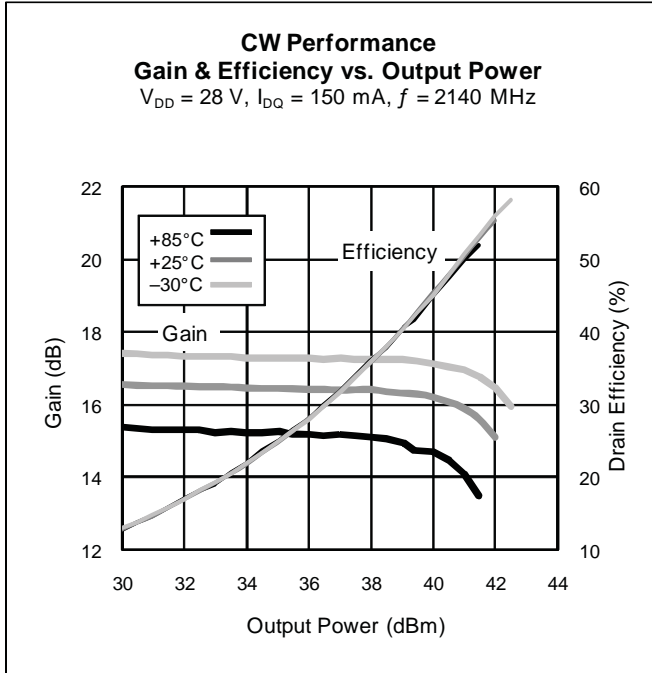

Reference Circuit, 2140 MHz

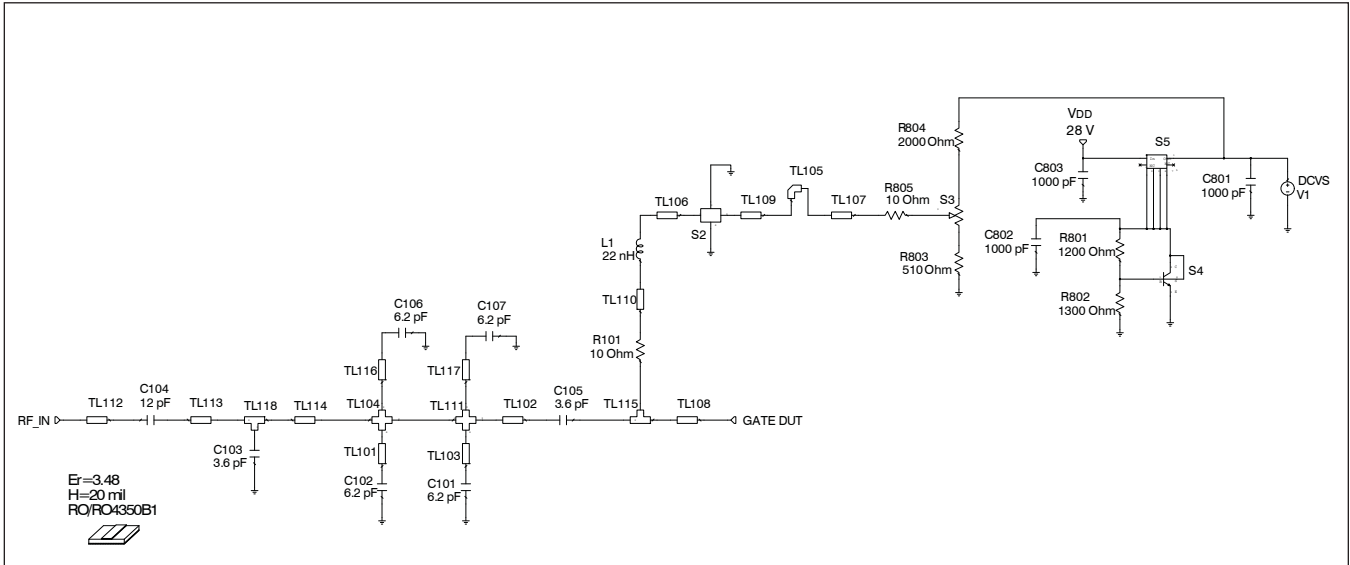

Reference circuit input schematic for $f = 2140$ MHz

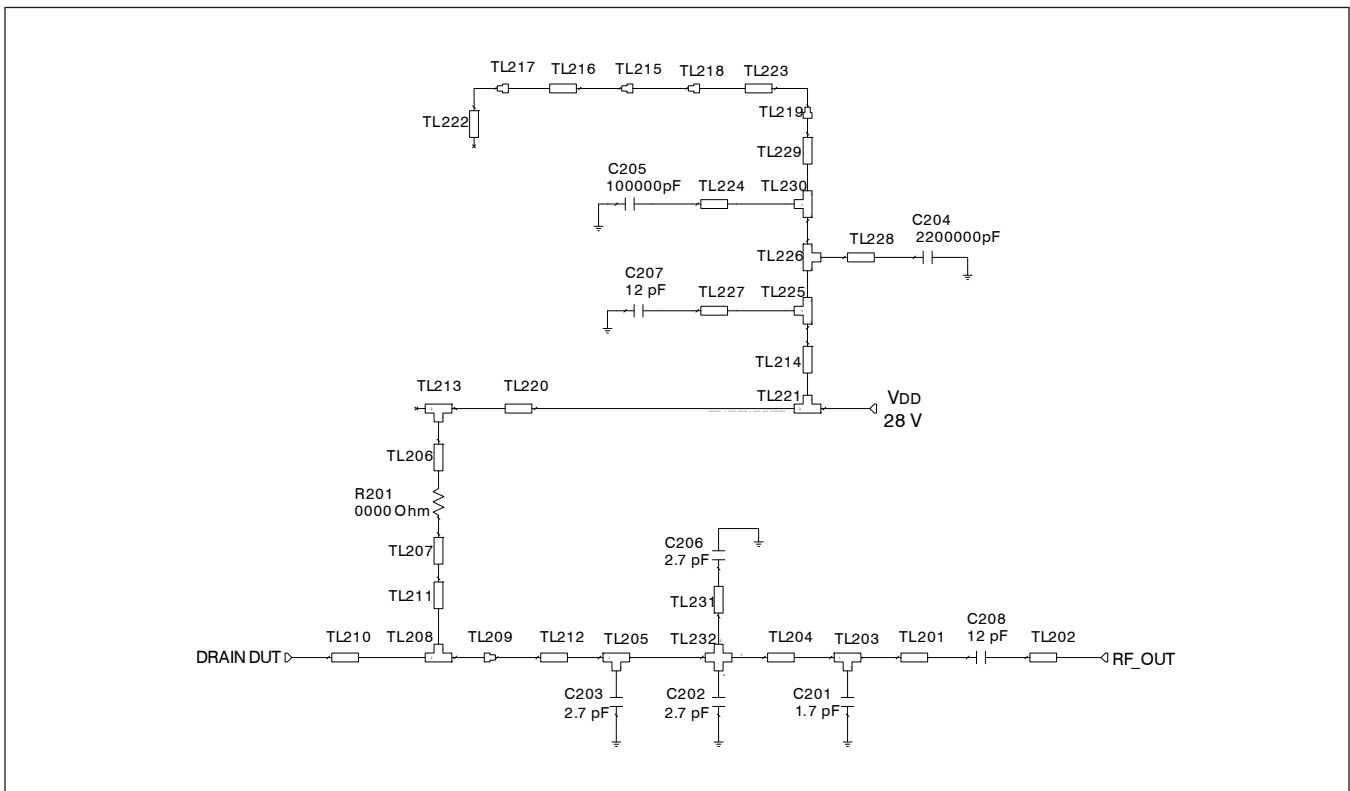

Reference circuit output schematic for $f = 2140$ MHz

Reference Circuit, 2140 MHz (cont.)
Description

DUT	PTFA220121M
PCB	0.508 mm [.020"] thick, $\epsilon_r = 3.48$, Rogers 4350, 1 oz. copper

Electrical Characteristics at 2140 MHz

Transmission Line	Electrical Characteristics	Dimensions: mm	Dimensions: mils
Input			
TL101, TL103	0.000 λ , 144.35 Ω	W = 0.025, L = 0.000	W = 1, L = 0
TL102	0.019 λ , 51.98 Ω	W = 1.087, L = 1.575	W = 43, L = 62
TL104, TL111		W1 = 1.087, W2 = 0.813, W3 = 1.087, W4 = 0.813	W1 = 43, W2 = 32, W3 = 43, W4 = 32
TL105		W = 1.524	W = 60
TL106	0.018 λ , 54.17 Ω	W = 1.016, L = 1.524	W = 40, L = 60
TL107	0.061 λ , 41.75 Ω	W = 1.524, L = 5.080	W = 60, L = 200
TL108	0.022 λ , 25.04 Ω	W = 3.048, L = 1.778	W = 120, L = 70
TL109	0.006 λ , 41.75 Ω	W = 1.524, L = 0.508	W = 60, L = 20
TL110	0.015 λ , 41.75 Ω	W = 1.524, L = 1.270	W = 60, L = 50
TL112	0.039 λ , 51.98 Ω	W = 1.087, L = 3.264	W = 43, L = 129
TL113	0.180 λ , 51.98 Ω	W = 1.087, L = 15.291	W = 43, L = 602
TL114	0.039 λ , 51.98 Ω	W = 1.087, L = 3.302	W = 43, L = 130
TL115	0.009 λ , 25.04 Ω	W1 = 3.048, W2 = 3.048, W3 = 0.762	W1 = 120, W2 = 120, W3 = 30
TL116, TL117	0.000 λ , 144.35 Ω	W = 0.025, L = 0.000	W = 1, L = 0
TL118	0.010 λ , 51.98 Ω	W1 = 1.087, W2 = 1.087, W3 = 0.813	W1 = 43, W2 = 43, W3 = 32

table continued next page

Reference Circuit, 2140 MHz (cont.)
Electrical Characteristics at 2140 MHz

Transmission Line	Electrical Characteristics	Dimensions: mm	Dimensions: mils
Output			
TL201	0.161 λ , 51.98 Ω	W = 1.087, L = 13.627	W = 43, L = 537
TL202	0.039 λ , 51.98 Ω	W = 1.087, L = 3.264	W = 43, L = 129
TL203, TL205	0.010 λ , 51.98 Ω	W1 = 1.087, W2 = 1.087, W3 = 0.813	W1 = 43, W2 = 43, W3 = 32
TL204	0.075 λ , 51.98 Ω	W = 1.087, L = 6.375	W = 43, L = 251
TL206	0.006 λ , 41.75 Ω	W = 1.524, L = 0.508	W = 60, L = 20
TL207	0.018 λ , 41.75 Ω	W = 1.524, L = 1.524	W = 60, L = 60
TL208	0.009 λ , 25.04 Ω	W1 = 3.048, W2 = 3.048, W3 = 0.762	W1 = 120, W2 = 120, W3 = 30
TL209		W1 = 1.087, W2 = 3.048	W1 = 43, W2 = 120
TL210	0.022 λ , 25.04 Ω	W = 3.048, L = 1.778	W = 120, L = 70
TL211	0.015 λ , 63.89 Ω	W = 0.762, L = 1.270	W = 30, L = 50
TL212	0.012 λ , 51.98 Ω	W = 1.087, L = 1.041	W = 43, L = 41
TL213	0.018 λ , 41.75 Ω	W1 = 1.524, W2 = 1.524, W3 = 1.524	W1 = 60, W2 = 60, W3 = 60
TL214	0.133 λ , 47.12 Ω	W = 1.270, L = 11.186	W = 50, L = 440
TL215		W1 = 0.020, W2 = 0.020, Offset = 0.007	W1 = 20, W2 = 780, Offset = 286
TL216	0.017 λ , 4.80 Ω	W = 19.850, L = 1.270	W = 782, L = 50
TL217		W1 = 0.001, W2 = 0.001, Offset = 0.011	W1 = 1, W2 = 50, Offset = 416
TL218		W1 = 0.005, W2 = 0.005, Offset = 0.000	W1 = 5, W2 = 208, Offset = 0
TL219		W1 = 0.001, W2 = 0.005, Offset = -0.002	W1 = 1, W2 = 208, Offset = -79
TL220	0.098 λ , 41.75 Ω	W = 1.524, L = 8.204	W = 60, L = 323
TL221	0.015 λ , 41.75 Ω	W1 = 1.524, W2 = 1.524, W3 = 1.270	W1 = 60, W2 = 60, W3 = 50
TL222	0.087 λ , 47.12 Ω	W = 1.270, L = 7.290	W = 50, L = 287
TL223	0.071 λ , 15.92 Ω	W = 5.283, L = 5.690	W = 208, L = 224
TL224	0.000 λ , 41.75 Ω	W = 1.524, L = 0.000	W = 60, L = 0
TL225	0.014 λ , 47.12 Ω	W = 1.270, W2 = 1.270, W3 = 1.191	W = 50, W2 = 50, W3 = 47
TL226	0.009 λ , 47.12 Ω	W = 1.270, W2 = 1.270, W3 = 0.762	W = 50, W2 = 50, W3 = 30
TL227	0.000 λ , 63.89 Ω	W = 0.762, L = 0.000	W = 30, L = 0
TL228	0.000 λ , 25.04 Ω	W = 3.048, L = 0.000	W = 120, L = 0
TL229	0.017 λ , 47.12 Ω	W = 1.270, L = 1.422	W = 50, L = 56
TL230	0.018 λ , 47.12 Ω	W1 = 1.270, W2 = 1.270, W3 = 1.524	W1 = 50, W2 = 50, W3 = 60
TL231	0.000 λ , 144.35 Ω	W = 0.025, L = 0.000	W = 1, L = 0
TL232		W1 = 1.087, W2 = 0.813, W3 = 1.087 W4 = 0.813	W1 = 43, W2 = 32, W3 = 43, W4 = 32

Reference Circuit, 2140 MHz (cont.)

Circuit Assembly Information

Test Fixture Part No. LTN/ PTFA220121M

Find Gerber files for this test fixture on the Infineon Web site at <http://www.infineon.com/rfpower>

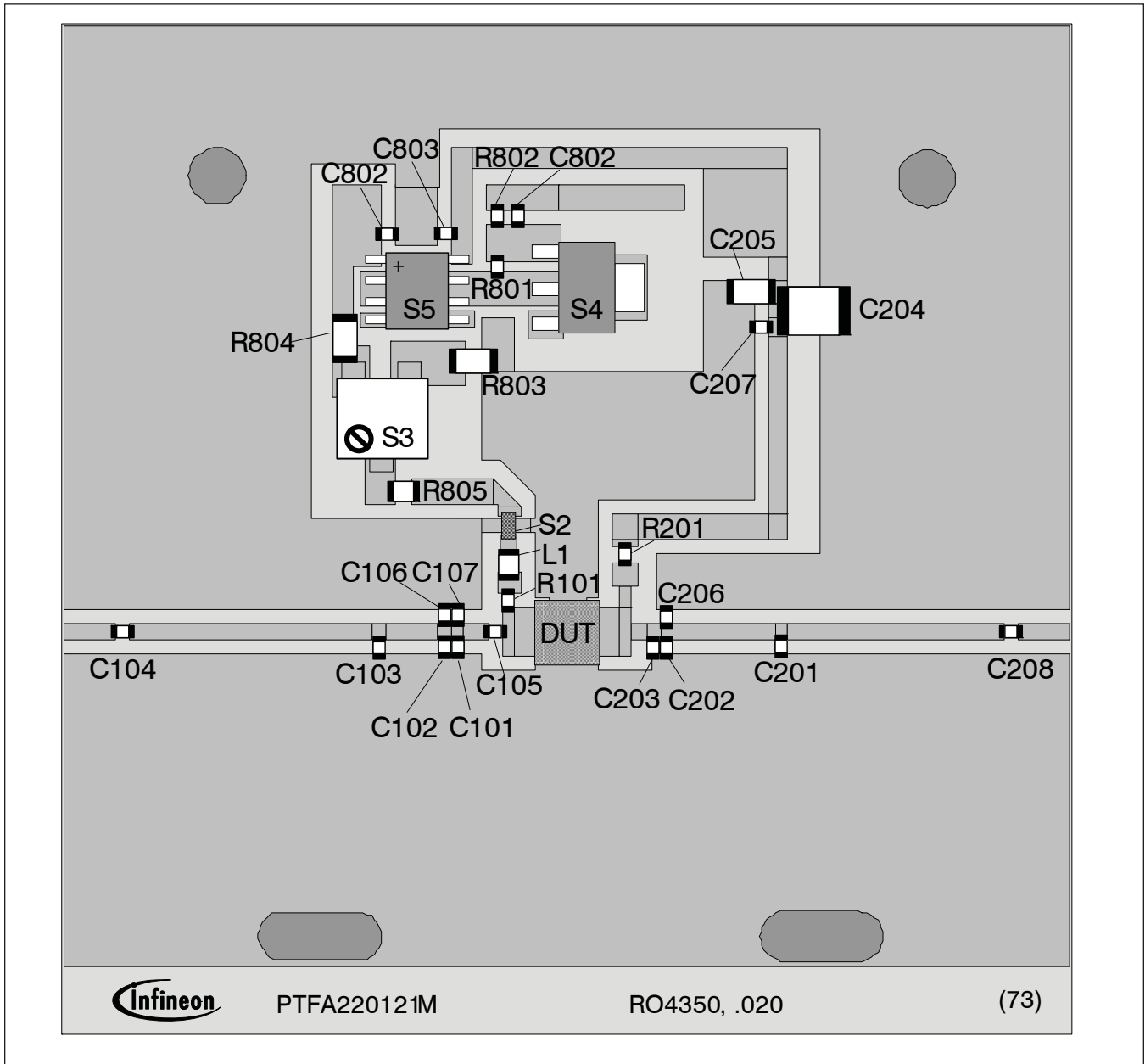

Reference circuit assembly diagram (not to scale)

Reference Circuit, 2140 MHz (cont.)
Components Information

Component	Description	Manufacturer	P/N
Input			
C101, C102, C106, C107	Chip capacitor, 6.2 pF	ATC	ATC100A6R2CW150X
C103, C105	Chip capacitor, 3.6 pF	ATC	ATC100A3R6CW150X
C104	Chip capacitor, 12 pF	ATC	ATC100A120JW150X
C801, C802, C803	Chip capacitor, 1000 pF	Panasonic Electronic Components	ECJ-1VB1H102K
L1	Inductor, 22 nH	Coilcraft	0805HT-22NX_BG
R101, R805	Resistor, 10 Ω	Panasonic Electronic Components	ERJ-8GEYJ100V
R801	Resistor, 1200 Ω	Panasonic Electronic Components	ERJ-8GEYJ122V
R802	Resistor, 1300 Ω	Panasonic Electronic Components	ERJ-8GEYJ132V
R803	Resistor, 510 Ω	Panasonic Electronic Components	ERJ-8GEYJ511V
R804	Resistor, 2000 Ω	Panasonic Electronic Components	ERJ-8GEYJ202V
S2	EMI Suppression Capacitor	Murata	NFM18PS105R0J3D
S3	Potentiometer, 2k Ω	Bourns Inc.	3224W-1-202E
S4	Transistor	Fairchild Semiconductor	BCP56
S5	Voltage regulator	Fairchild Semiconductor	LM7805
Output			
C201	Chip capacitor, 1.7 pF	ATC	ATC100A1R7CW150X
C202, C203, C206	Chip capacitor, 2.7 pF	ATC	ATC100A2R7CW150X
C204	Chip capacitor, 2.2 μ F	TDK Corporation	C4532X7R1H225M160KA
C205	Chip capacitor, 0.1 μ F	Panasonic Electronic Components	ECJ-3VB1H104K
C207, C208	Chip capacitor, 12 pF	ATC	ATC100A120JW150X
R201	Resistor, 0.0 Ω	Panasonic Electronic Components	ERJ-8GEY0R00V

Package Outline Specifications

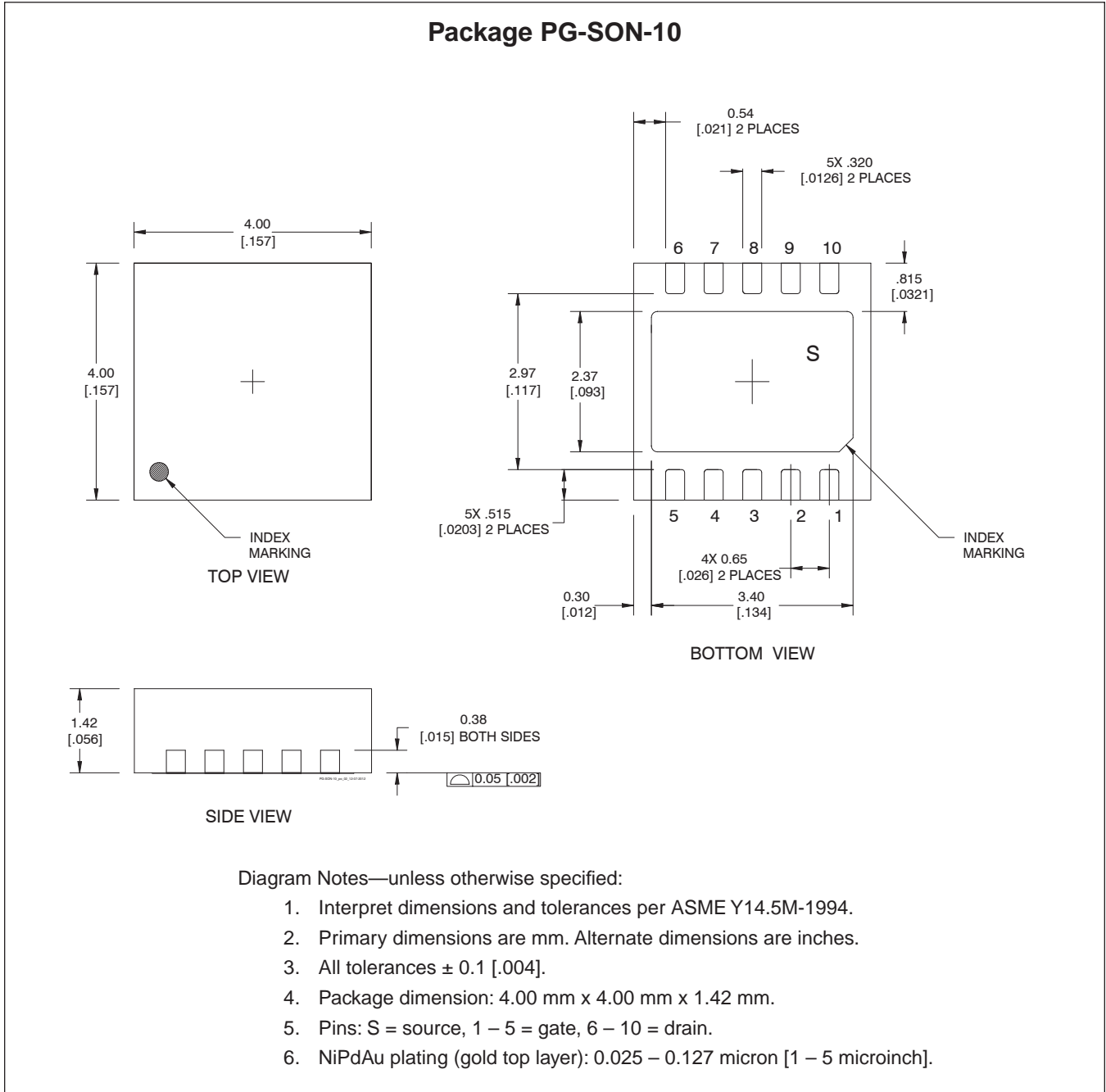

Find the latest and most complete information about products and packaging at the Infineon Internet page <http://www.infineon.com/rfpower>

Revision History: 2013-06-17

Data Sheet

Previous Revision: 2011-04-11, Data Sheet

Page	Subjects (major changes since last revision)
2	Change shipping quantity from 500 pcs. to 1,000 pcs.

We Listen to Your Comments

Any information within this document that you feel is wrong, unclear or missing at all?
Your feedback will help us to continuously improve the quality of this document.
Please send your proposal (including a reference to this document) to:

highpowerRF@infineon.com

To request other information, contact us at:
+1 877 465 3667 (1-877-GO-LDMOS) USA
or +1 408 776 0600 International

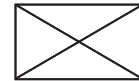

Edition 2015-10-23

**Published by
Infineon Technologies AG
85579 Neubiberg, Germany**

**© 2009 – 2015 Infineon Technologies AG
All Rights Reserved.**

Legal Disclaimer

The information given in this document shall in no event be regarded as a guarantee of conditions or characteristics. With respect to any examples or hints given herein, any typical values stated herein and/or any information regarding the application of the device, Infineon Technologies hereby disclaims any and all warranties and liabilities of any kind, including without limitation, warranties of non-infringement of intellectual property rights of any third party.

Information

For further information on technology, delivery terms and conditions and prices, please contact the nearest Infineon Technologies Office (www.infineon.com/rfpower).

Warnings

Due to technical requirements, components may contain dangerous substances. For information on the types in question, please contact the nearest Infineon Technologies Office.

Infineon Technologies components may be used in life-support devices or systems only with the express written approval of Infineon Technologies, if a failure of such components can reasonably be expected to cause the failure of that life-support device or system or to affect the safety or effectiveness of that device or system. Life support devices or systems are intended to be implanted in the human body or to support and/or maintain and sustain and/or protect human life. If they fail, it is reasonable to assume that the health of the user or other persons may be endangered.