



Micro Commercial Components

Micro Commercial Components
20736 Marilla Street Chatsworth
CA 91311
Phone: (818) 701-4933
Fax: (818) 701-4939

Features

- Lead Free Finish/RoHS Compliant ("P" Suffix designates RoHS Compliant. See ordering information)
- Extremely Low Thermal Resistance
- For Surface Mount Application and High Current Capability
- Higher Temp Soldering: 260°C for 10 Seconds At Terminals
- Case Material: Molded Plastic. UL Flammability Classification Rating 94V-0 and MSL Rating 1

Maximum Ratings

- Operating Temperature: -55°C to +125°C
- Storage Temperature: -55°C to +150°C
- Maximum Thermal Resistance: 5°C/W Junction to Lead

MCC Catalog Number	Device Marking	Maximum Recurrent Peak Reverse Voltage	Maximum RMS Voltage	Maximum DC Blocking Voltage
MBRX0520	2	20V	14V	20V
MBRX0530	3	30V	21V	30V
MBRX0540	4	40V	28V	40V
MBRX0560	6	60V	42V	60V

Electrical Characteristics @ 25°C Unless Otherwise Specified

Average Forward Current	$I_{F(AV)}$	0.5A	$T_J=90^\circ\text{C}$
Peak Forward Surge Current	I_{FSM}	5A	8.3ms half sine
Maximum Instantaneous Forward Voltage MBRX0520 MBRX0530 MBRX0540 MBRX0560	V_F	0.45V 0.55V 0.55V 0.70V	$I_{FM}=0.5A$ $T_J=25^\circ\text{C}$
Maximum DC Reverse Current At Rated DC Blocking Voltage	I_R	0.3mA	$T_A=25^\circ\text{C}$
Typical Junction Capacitance	C_J	30pF	Measured at 1.0MHz, $V_R=4.0V$
Power Dissipation	P_D	250mW	

**MBRX0520
THRU
MBRX0560**

**0.5 Amp
Schottky Rectifier
20 to 60 Volts**

SOD323

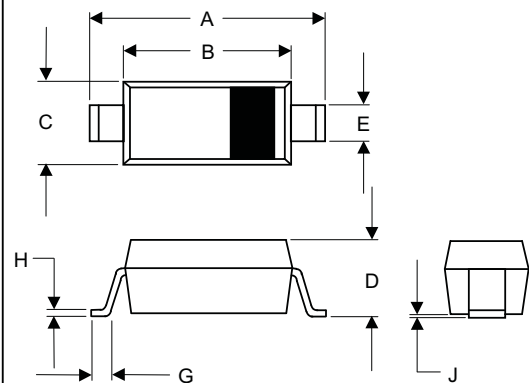

DIM	INCHES		MM		NOTE
	MIN	MAX	MIN	MAX	
A	.090	.113	2.30	2.88	
B	.063	.071	1.60	1.80	
C	.045	.053	1.15	1.35	
D	.031	.049	0.80	1.24	
E	.010	.016	0.25	0.40	
G	.004	.018	0.10	0.45	
H	.004	.010	0.10	0.25	
J	-----	.006	-----	0.15	

SUGGESTED SOLDER PAD LAYOUT

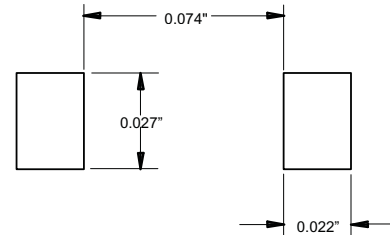

MBRX0520 thru MBRX0560



Micro Commercial Components

Figure 1
Typical Forward Characteristics
MBRX0520

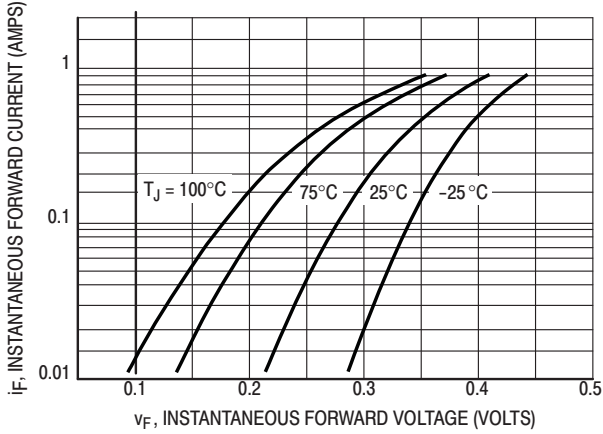

Figure 2
Typical Forward Characteristics
MBRX0530~MBRX0540

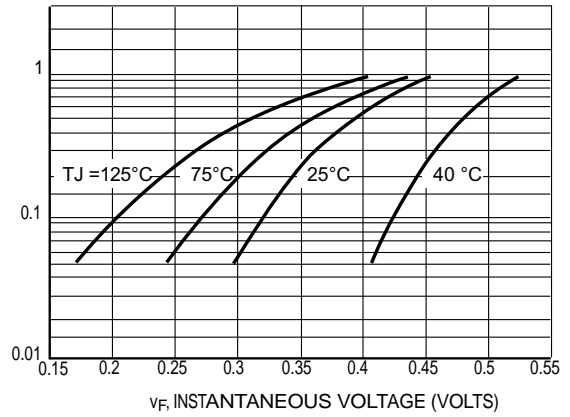

Figure 3
Typical Forward Characteristics
MBRX0560

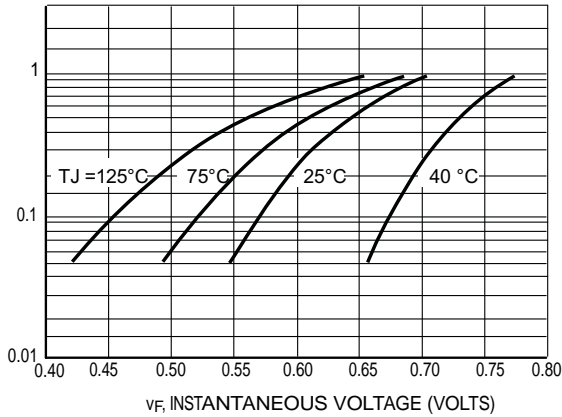
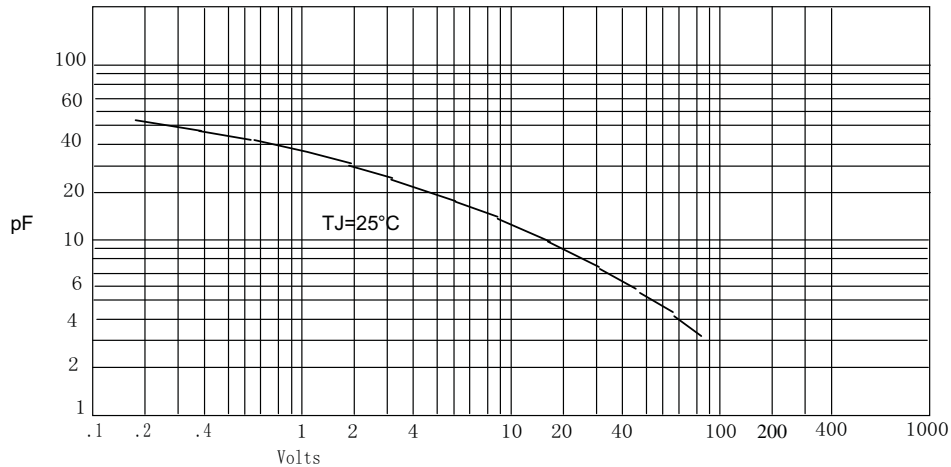
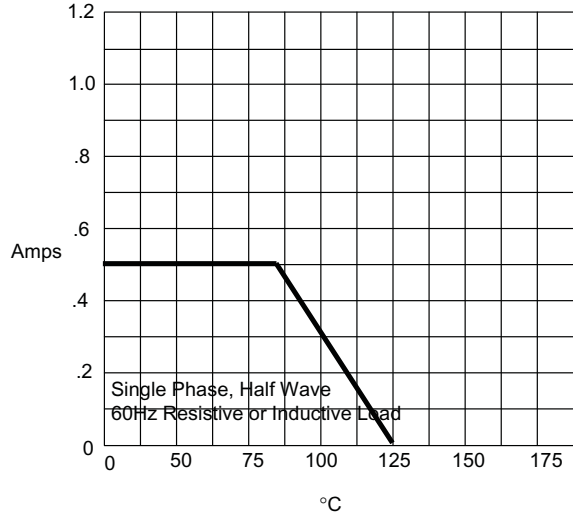

Figure 4
Junction Capacitance



MBRX0520 thru MBRX0560

Figure 5
Forward Derating Curve



Average Forward Rectified Current - Amperes versus Ambient Temperature - °C

Figure 6
Peak Forward Surge Current

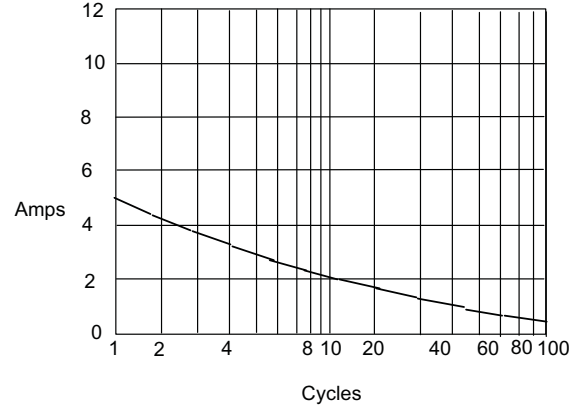

Peak Forward Surge Current - Amperes versus Number Of Cycles At 60Hz - Cycles



Micro Commercial Components

Ordering Information

Device	Packing
(Part Number)-TP	Tape&Reel;3Kpcs/Reel

*****IMPORTANT NOTICE*****

Micro Commercial Components Corp. reserves the right to make changes without further notice to any product herein to make corrections, modifications, enhancements, improvements, or other changes. *Micro Commercial Components Corp.* does not assume any liability arising out of the application or use of any product described herein; neither does it convey any license under its patent rights, nor the rights of others. The user of products in such applications shall assume all risks of such use and will agree to hold *Micro Commercial Components Corp.* and all the companies whose products are represented on our website, harmless against all damages.

*****APPLICATIONS DISCLAIMER*****

Products offer by *Micro Commercial Components Corp.* are not intended for use in Medical, Aerospace or Military Applications.