

GenX3™ 300V IGBT

IXGA42N30C3 IXGH42N30C3 IXGP42N30C3

High Speed PT IGBTs for
50-150kHz switching

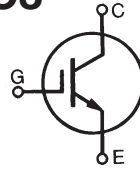

$V_{CES} = 300V$
 $I_{C110} = 42A$
 $V_{CE(sat)} \leq 1.85V$
 $t_{fi\ typ} = 65ns$

Symbol	Test Conditions	Maximum Ratings	
V_{CES}	$T_J = 25^\circ C$ to $150^\circ C$	300	V
V_{CGR}	$T_J = 25^\circ C$ to $150^\circ C$, $R_{GE} = 1M\Omega$	300	V
V_{GES}	Continuous	± 20	V
V_{GEM}	Transient	± 30	V
I_{C110}	$T_C = 110^\circ C$ (chip capability)	42	A
I_{CM}	$T_C = 25^\circ C$, 1ms	250	A
I_A	$T_C = 25^\circ C$	42	A
E_{AS}	$T_C = 25^\circ C$	250	mJ
SSOA (RBSOA)	$V_{GE} = 15V$, $T_{VJ} = 125^\circ C$, $R_G = 10\Omega$ Clamped inductive load @ $\leq 300V$	$I_{CM} = 84$	A
P_C	$T_C = 25^\circ C$	223	W
T_J		-55 ... +150	$^\circ C$
T_{JM}		150	$^\circ C$
T_{stg}		-55 ... +150	$^\circ C$
T_L	Maximum lead temperature for soldering	300	$^\circ C$
T_{SOLD}	1.6mm (0.062 in.) from case for 10s	260	$^\circ C$
M_d	Mounting torque (TO-247)(TO-220)	1.13/10	Nm/lb.in.
Weight	TO-263	2.5	g
	TO-247	6.0	g
	TO-220	3.0	g

TO-263 (IXGA)

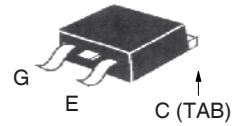

TO-247 (IXGH)

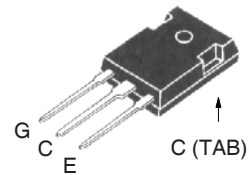

TO-220 (IXGP)

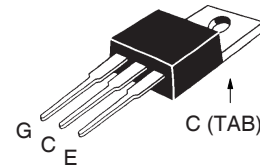

G = Gate C = Collector
 E = Emitter TAB = Collector

Features

- Optimized for low switching losses
- Square RBSOA
- High current handling capability
- International standard packages

Advantages

- High power density
- Low gate drive requirement

Applications

- High Frequency Power Inverters
- UPS
- Motor Drives
- SMPS
- PFC Circuits
- Battery Chargers
- Welding Machines
- Lamp Ballasts

Symbol	Test Conditions	Characteristic Values		
		Min.	Typ.	Max.
BV_{CES}	$I_C = 250\mu A$, $V_{GE} = 0V$	300		V
$V_{GE(th)}$	$I_C = 250\mu A$, $V_{CE} = V_{GE}$	2.5		5.0 V
I_{CES}	$V_{CE} = V_{CES}$			25 μA
	$V_{GE} = 0V$ $T_J = 125^\circ C$			500 μA
I_{GES}	$V_{CE} = 0V$, $V_{GE} = \pm 20V$			± 100 nA
$V_{CE(sat)}$	$I_C = 42A$, $V_{GE} = 15V$, Note1		1.54	1.85 V
	$T_J = 125^\circ C$		1.54	V

Symbol	Test Conditions	Characteristic Values		
		Min.	Typ.	Max.
g_{fs}	$I_C = 0.5 \cdot I_{C110}, V_{CE} = 10V, \text{Note 1}$	20	33	S
C_{ies}	$V_{CE} = 25V, V_{GE} = 0V, f = 1MHz$		2140	pF
C_{oes}			218	pF
C_{res}			60	pF
Q_g	$I_C = I_{C110}, V_{GE} = 15V, V_{CE} = 0.5 \cdot V_{CES}$		76	nC
Q_{ge}			15	nC
Q_{gc}			26	nC
$t_{d(on)}$	Inductive Load, $T_J = 25^\circ C$ $I_C = 0.5 \cdot I_{C110}, V_{GE} = 15V$ $V_{CE} = 200V, R_G = 10\Omega$		21	ns
t_{ri}			23	ns
E_{on}			0.12	mJ
$t_{d(off)}$			113	170 ns
t_{fi}			65	120 ns
E_{off}		0.15	0.28 mJ	
$t_{d(on)}$	Inductive Load, $T_J = 125^\circ C$ $I_C = 0.5 \cdot I_{C110}, V_{GE} = 15V$ $V_{CE} = 200V, R_G = 10\Omega$		21	ns
t_{ri}			22	ns
E_{on}			0.21	mJ
$t_{d(off)}$			127	ns
t_{fi}			102	ns
E_{off}		0.20	mJ	
R_{thJC}			0.56	$^\circ C/W$
R_{thCK}	TO-220	0.50		$^\circ C/W$
	TO-247	0.25		$^\circ C/W$

TO-247 AD Outline

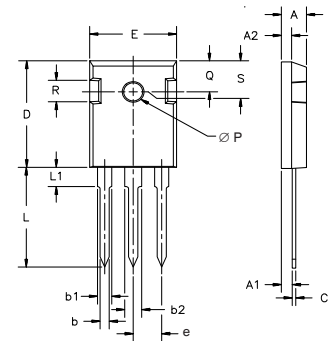

Dim.	Millimeter		Inches	
	Min.	Max.	Min.	Max.
A	4.7	5.3	.185	.209
A ₁	2.2	2.54	.087	.102
A ₂	2.2	2.6	.059	.098
b	1.0	1.4	.040	.055
b ₁	1.65	2.13	.065	.084
b ₂	2.87	3.12	.113	.123
C	.4	.8	.016	.031
D	20.80	21.46	.819	.845
E	15.75	16.26	.610	.640
e	5.20	5.72	0.205	0.225
L	19.81	20.32	.780	.800
L1		4.50		.177
∅P	3.55	3.65	.140	.144
Q	5.89	6.40	0.232	0.252
R	4.32	5.49	.170	.216
S	6.15	BSC	.242	BSC

Note1. Pulse test, $t \leq 300\mu s$; duty cycle, $d \leq 2\%$.

TO-220 (IXGP) Outline

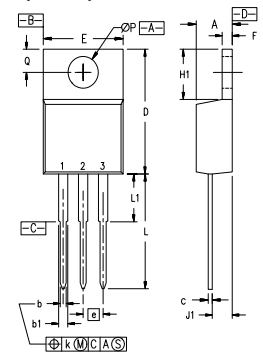

Pins: 1 - Gate 2 - Drain

SYM	INCHES		MILLIMETERS	
	MIN	MAX	MIN	MAX
A	.170	.190	4.32	4.83
b	.025	.040	0.64	1.02
b1	.045	.065	1.15	1.65
c	.014	.022	0.35	0.56
D	.580	.630	14.73	16.00
E	.390	.420	9.91	10.66
e	.100	BSC	2.54	BSC
F	.045	.055	1.14	1.40
H1	.230	.270	5.85	6.85
J1	.090	.110	2.29	2.79
k	0	.015	0	0.38
L	.500	.550	12.70	13.97
L1	.110	.230	2.79	5.84
∅P	.139	.161	3.53	4.08
Q	.100	.125	2.54	3.18

TO-263 (IXGA) Outline

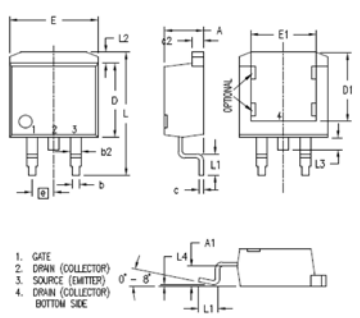

SYM	INCHES		MILLIMETERS	
	MIN	MAX	MIN	MAX
A	.160	.190	4.06	4.83
A1	.080	.110	2.03	2.79
b	.020	.039	0.51	0.99
b2	.045	.055	1.14	1.40
c	.016	.029	0.40	0.74
c2	.045	.055	1.14	1.40
D	.340	.380	8.64	9.65
D1	.315	.350	8.00	8.89
E	.380	.410	9.65	10.41
E1	.245	.320	6.22	8.13
e	.100	BSC	2.54	BSC
L	.575	.625	14.61	15.88
L1	.090	.110	2.29	2.79
L2	.040	.055	1.02	1.40
L3	.050	.070	1.27	1.78
L4	0	.005	0	0.13

IXYS reserves the right to change limits, test conditions, and dimensions.

IXYS MOSFETs and IGBTs are covered by one or more of the following U.S. patents:	4,835,592	4,931,844	5,049,961	5,237,481	6,162,665	6,404,065 B1	6,683,344	6,727,585	7,005,734 B2	7,157,338B2
	4,850,072	5,017,508	5,063,307	5,381,025	6,259,123 B1	6,534,343	6,710,405 B2	6,759,692	7,063,975 B2	
	4,881,106	5,034,796	5,187,117	5,486,715	6,306,728 B1	6,583,505	6,710,463	6,771,478 B2	7,071,537	

Fig. 1. Output Characteristics @ 25°C

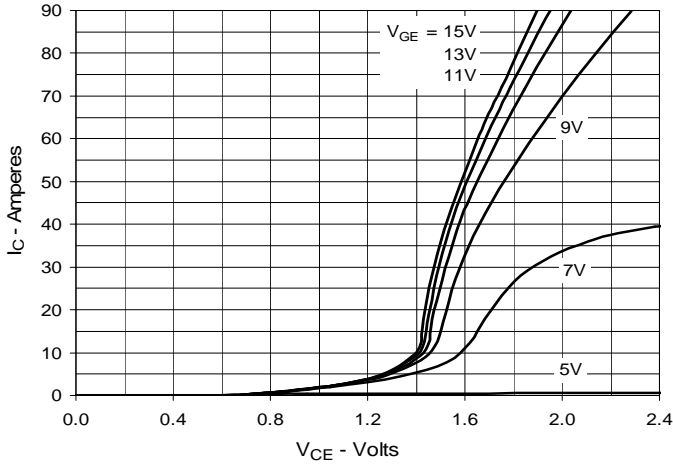

Fig. 2. Extended Output Characteristics @ 25°C

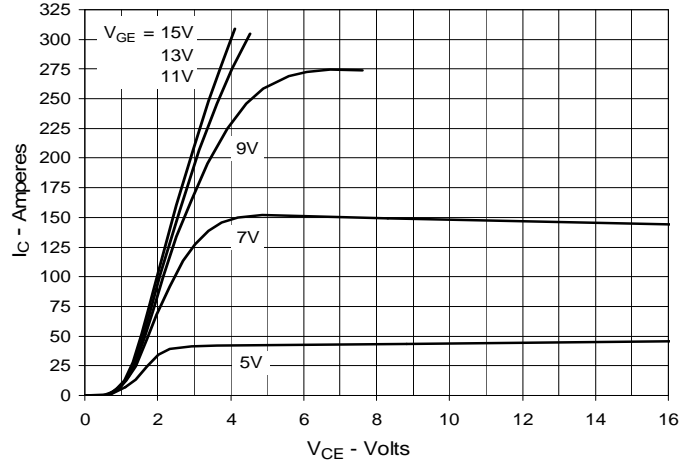

Fig. 3. Output Characteristics @ 125°C

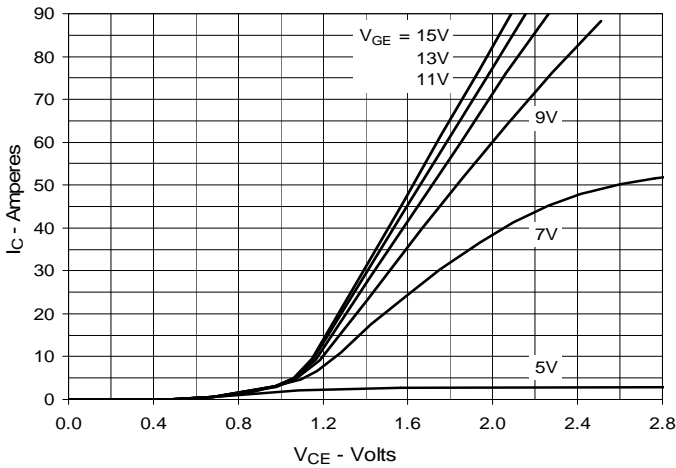

Fig. 4. Dependence of Vce(sat) on Junction Temperature

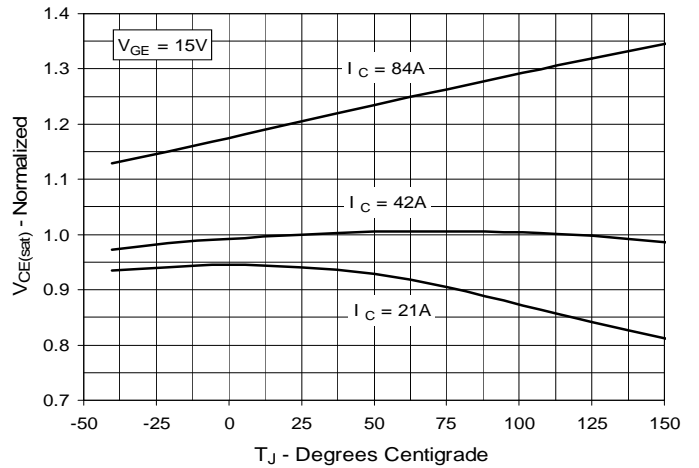

Fig. 5. Collector-to-Emitter Voltage vs. Gate-to-Emitter Voltage

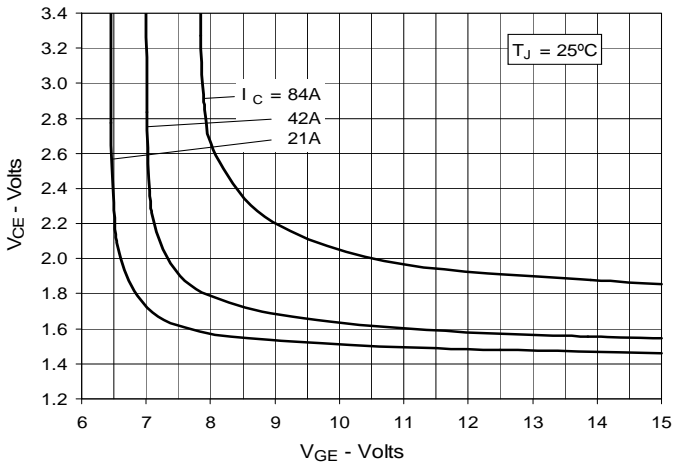

Fig. 6. Input Admittance

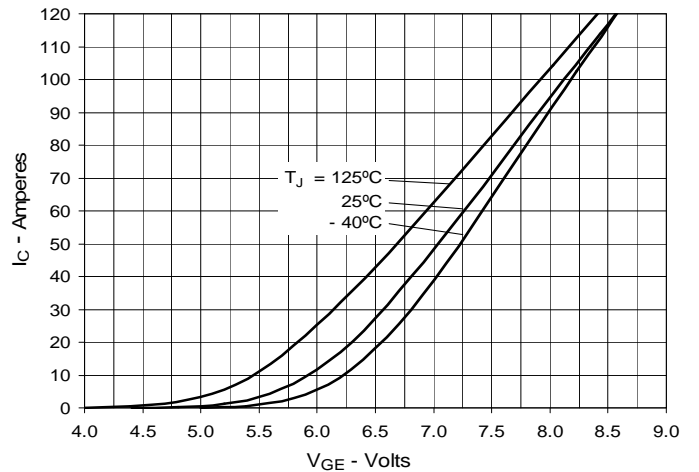

Fig. 7. Transconductance

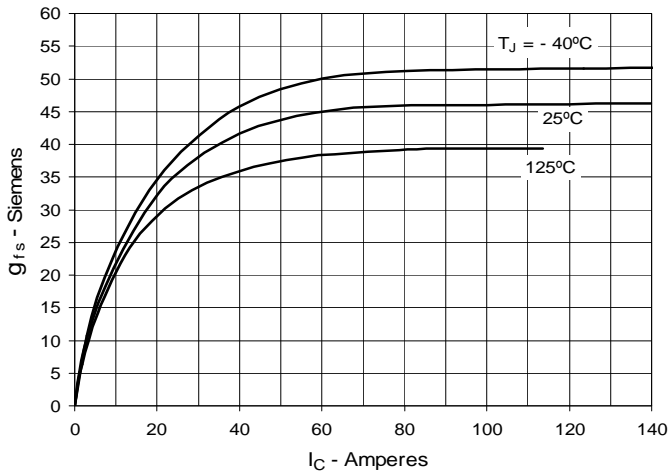

Fig. 8. Gate Charge

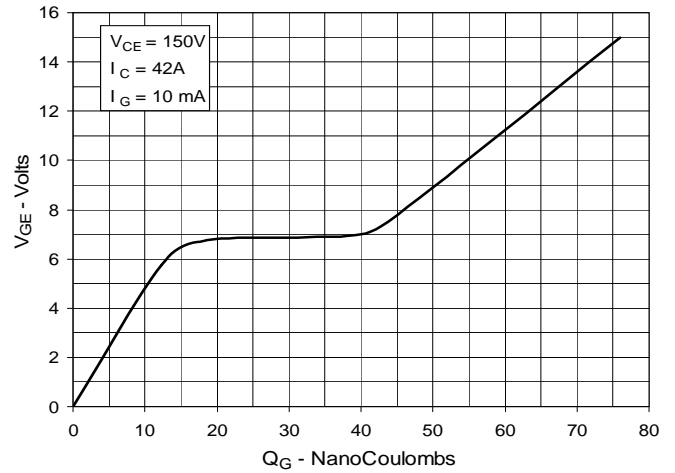

Fig. 9. Capacitance

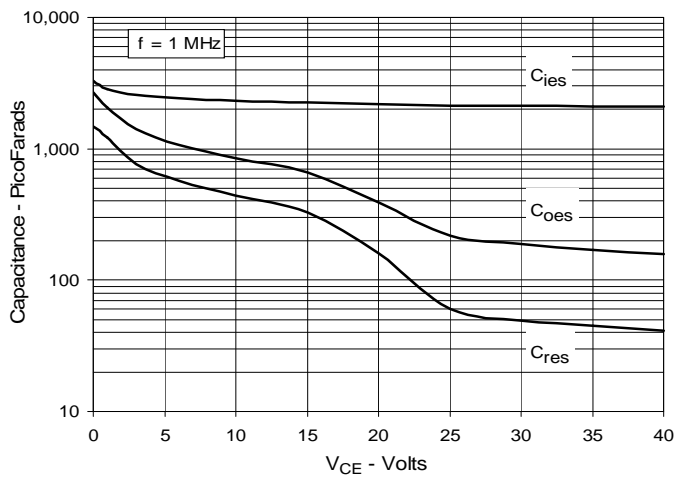

Fig. 10. Reverse-Bias Safe Operating Area

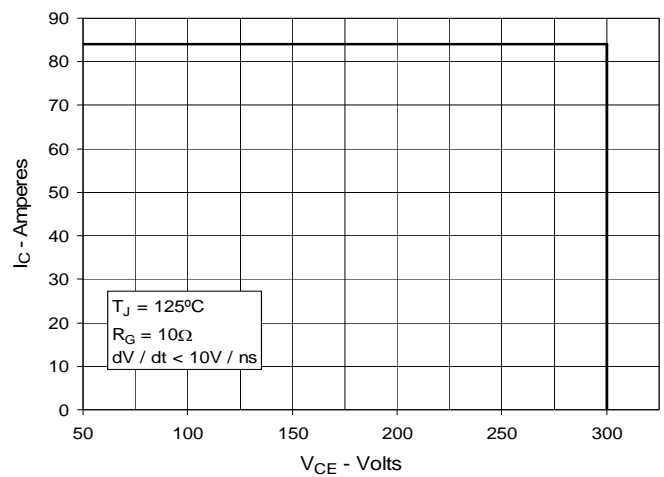

Fig. 11. Maximum Transient Thermal Impedance

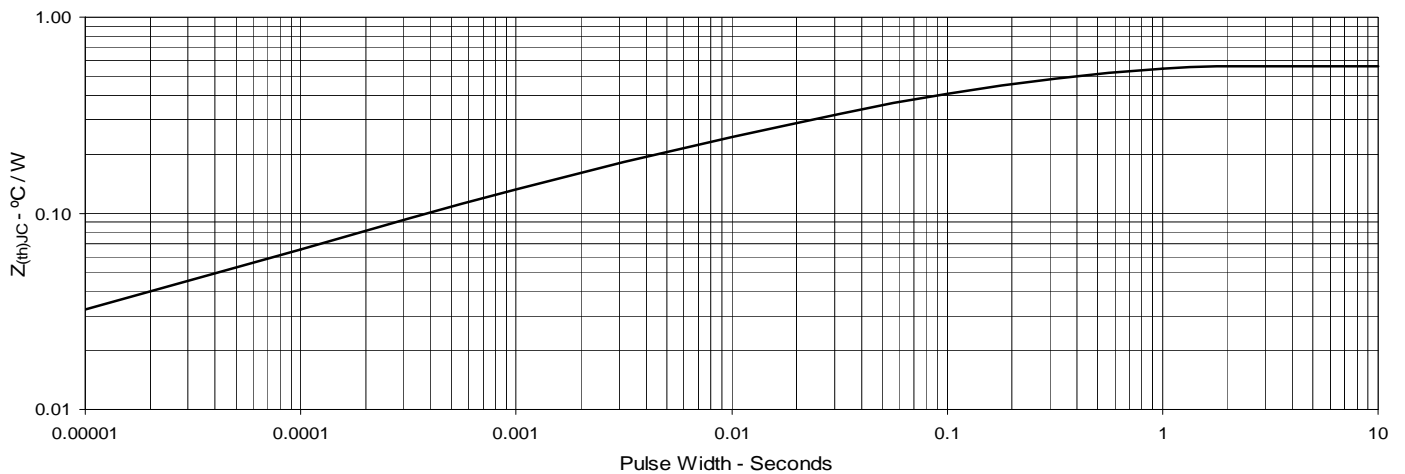

Fig. 12. Inductive Switching Energy Loss vs. Gate Resistance

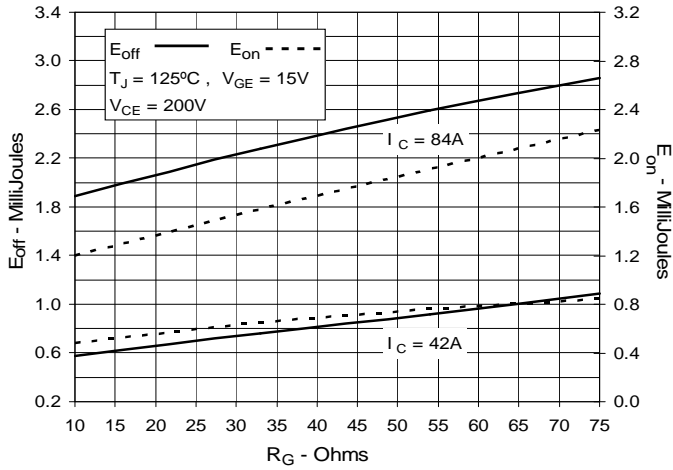

Fig. 13. Inductive Switching Energy Loss vs. Collector Current

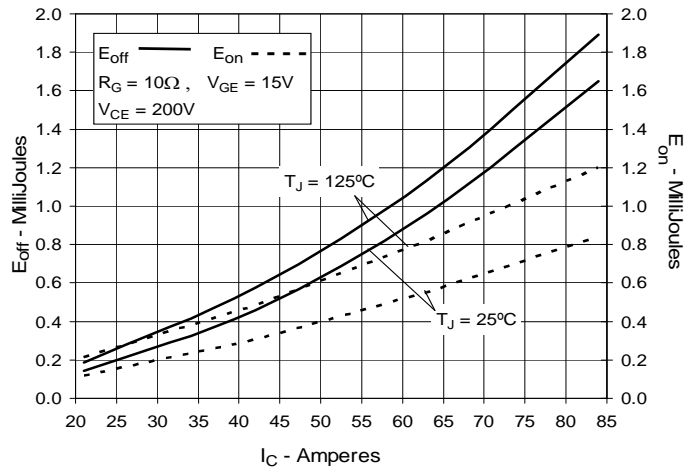

Fig. 14. Inductive Switching Energy Loss vs. Junction Temperature

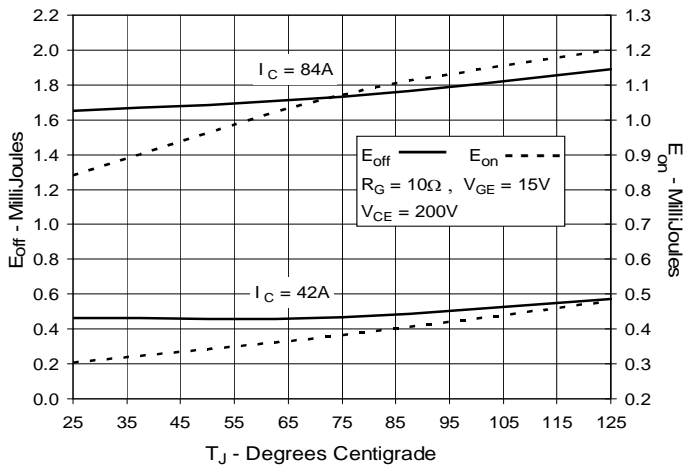

Fig. 15. Inductive Turn-off Switching Times vs. Gate Resistance

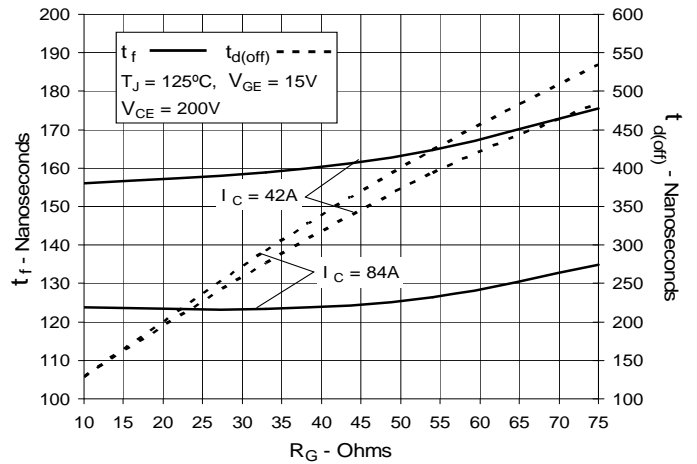

Fig. 16. Inductive Turn-off Switching Times vs. Collector Current

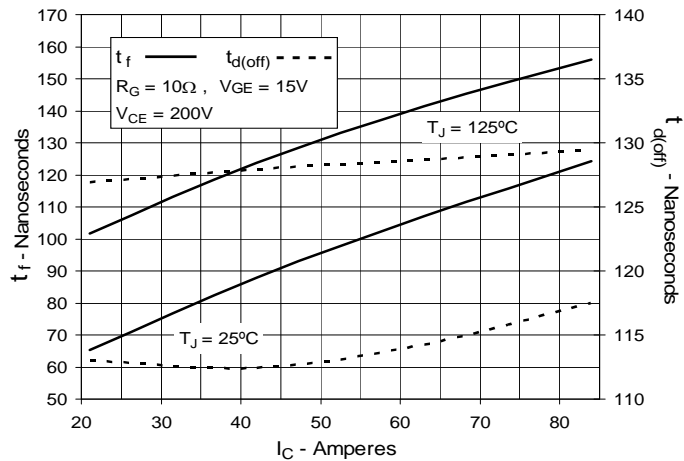

Fig. 17. Inductive Turn-off Switching Times vs. Junction Temperature

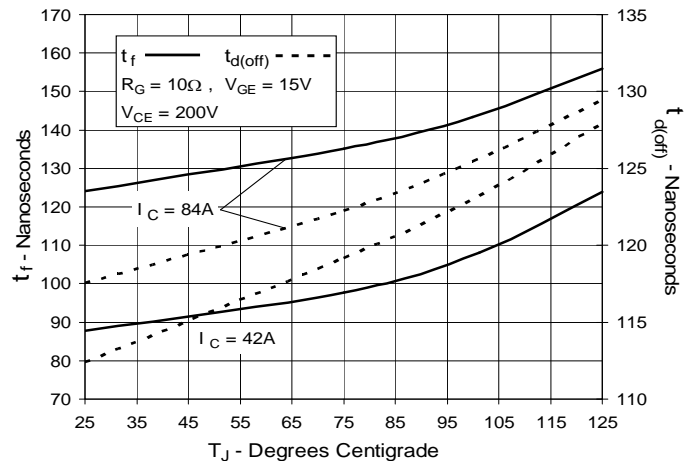

Fig. 18. Inductive Turn-on Switching Times vs. Gate Resistance

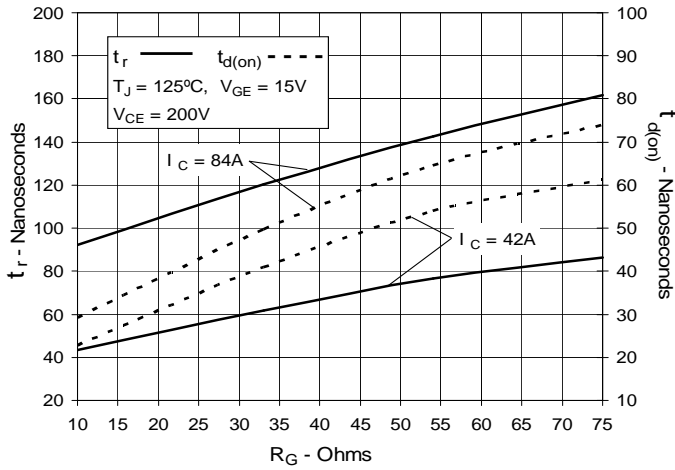

Fig. 19. Inductive Turn-on Switching Times vs. Collector Current

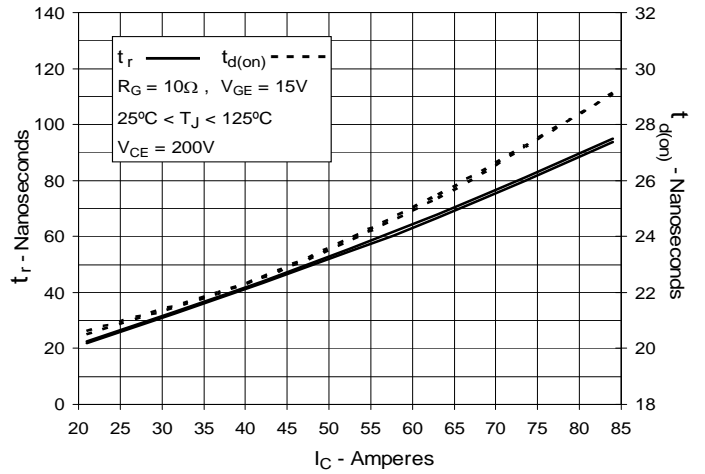

Fig. 20. Inductive Turn-on Switching Times vs. Junction Temperature

