

300mA Low Dropout Positive Voltage Regulator

General Description

The RT9162 is a positive low dropout regulator designed for applications requiring low dropout performance at full rated current. The device is available in fixed output voltages of 3.3V and 3.5V. The RT9162 provides excellent regulation over line, load, and temperature variations.

The other features include low dropout performance at a maximum of 1.3V at 300mA, fast transient response, internal current limiting, and thermal shutdown protection of the output devices. The RT9162 is a three-terminal regulator compatible with industrial 78XX series and available in surface mount SOT-89 packages.

Ordering Information

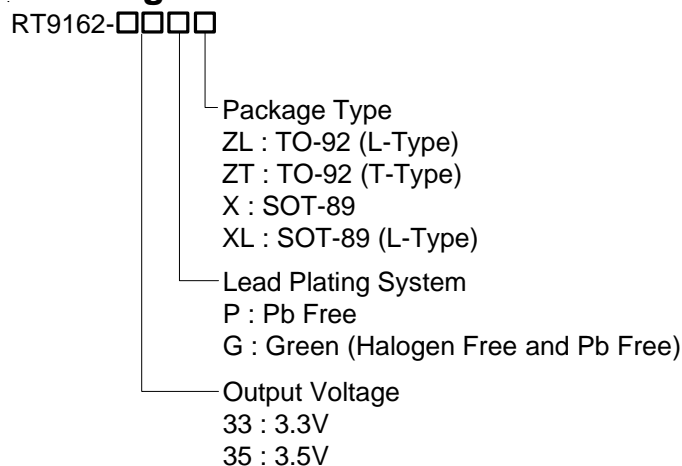

Note :

Richtek products are :

- ▶ RoHS compliant and compatible with the current requirements of IPC/JEDEC J-STD-020.
- ▶ Suitable for use in SnPb or Pb-free soldering processes.

Marking Information

For marking information, contact our sales representative directly or through a Richtek distributor located in your area.

Features

- Low Dropout, Maximum 1.3V at 300mA
- Fast Transient Response
- ± 2% Total Output Regulation
- 0.4% Line Regulation
- 0.4% Load Regulation
- SOT-89 and TO-92 Packages
- RoHS Compliant and 100% Lead (Pb)-Free

Applications

- 5V to 3.3V Linear Regulator
- Low Voltage Microcontroller, DSF, ... etc. Power Supply
- Linear Regulator for LAN Card and CD-ROM

Pin Configurations

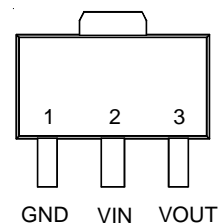
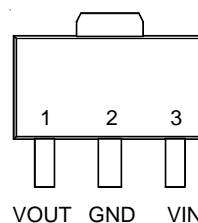
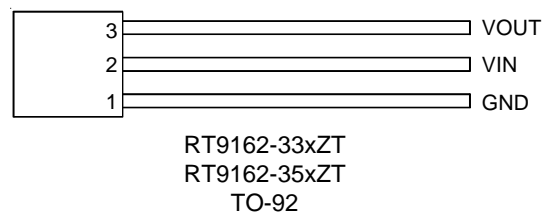
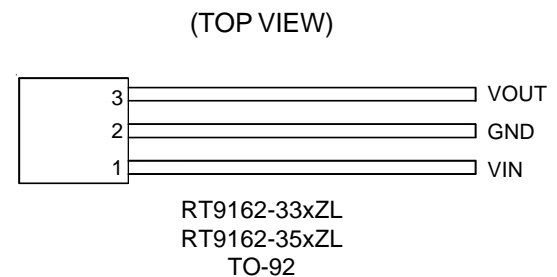

Typical Application Circuit

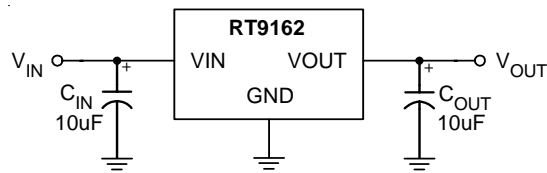

Functional Pin Description

Pin Name	Pin Function
VOUT	Output Voltage
GND	Ground
VIN	Power Input

Function Block Diagram

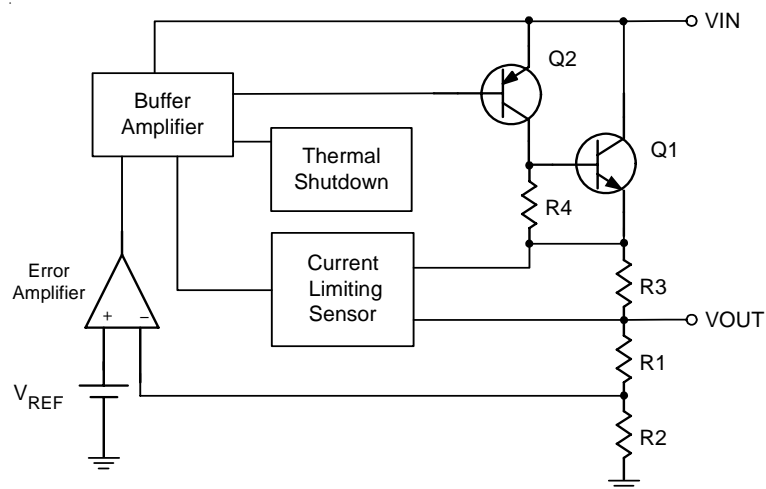

Absolute Maximum Ratings

- Input Voltage ----- 15V
- Power Dissipation, P_D @ $T_A = 25^\circ\text{C}$
 - TO-92 ----- 0.625W
 - SOT-89 ----- 0.571W
- Package Thermal Resistance (Note 1)
 - TO-92, θ_{JA} ----- 160°C/W
 - SOT-89, θ_{JA} ----- 175°C/W
- Operating Junction Temperature Range ----- -40°C to 125°C
- Storage Temperature Range ----- -65°C to 150°C

Electrical Characteristics

($V_{IN} = 5.0\text{V}$, $T_A = 25^\circ\text{C}$, unless otherwise specified)

Parameter		Symbol	Test Conditions	Min	Typ	Max	Unit
Output Voltage (Note 2)	RT9162-33	V_{OUT}		3.235	3.300	3.365	V
	RT9162-35			3.430	3.500	3.570	
Line Regulation (Note 2)		ΔV_{LINE}	$V_{IN} = 5\text{V} - 15\text{V}$	--	0.1	0.4	%
Load Regulation (Note 2)		ΔV_{LOAD}	$I_L = 0 - 300\text{mA}$	--	0.2	0.4	%
Dropout Voltage (Note 3)		V_{DROP}	$\Delta V_{OUT} = 1\%$	--	1.2	1.3	V
Current Limit		I_{LIM}		400	--	--	mA
Quiescent Current		I_Q		--	4.5	8	mA
Temperature Coefficient		T_C		--	0.005	--	%/ $^\circ\text{C}$
Temperature Stability		T_S		--	0.5	--	%
RMS Output Noise (Note 4)				--	0.003	--	% V_{OUT}

Note 1. θ_{JA} is measured in the natural convection at $T_A = 25^\circ\text{C}$ on a low effective thermal conductivity test board of JEDEC 51-3 thermal measurement standard.

Note 2. Low duty cycle pulse testing with Kelvin connections required.

Note 3. The dropout voltage is defined as $V_{IN} - V_{OUT}$, which is measured when V_{OUT} is $V_{OUT(NORMAL)} - 100\text{mV}$.

Note 4. Bandwidth of 10 Hz to 10 kHz.

Outline Dimension

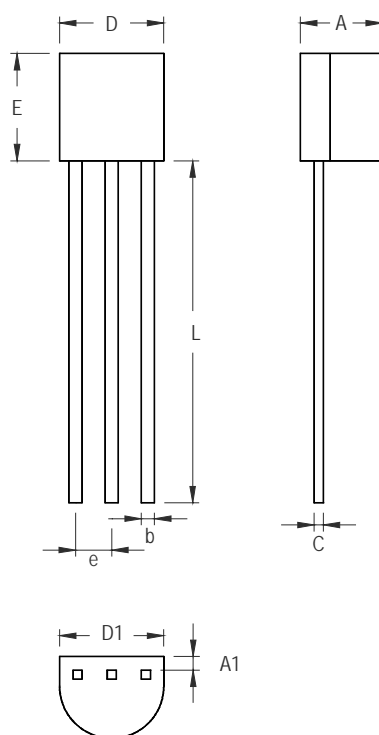

Symbol	Dimensions In Millimeters		Dimensions In Inches	
	Min	Max	Min	Max
A	3.175	4.191	0.125	0.165
A1	1.143	1.372	0.045	0.054
b	0.406	0.533	0.016	0.021
C	0.406	0.533	0.016	0.021
D	4.445	5.207	0.175	0.205
D1	3.429	5.029	0.135	0.198
E	4.318	5.334	0.170	0.210
e	1.143	1.397	0.045	0.055
L	12.700		0.500	

3-Lead TO-92 Plastic Package

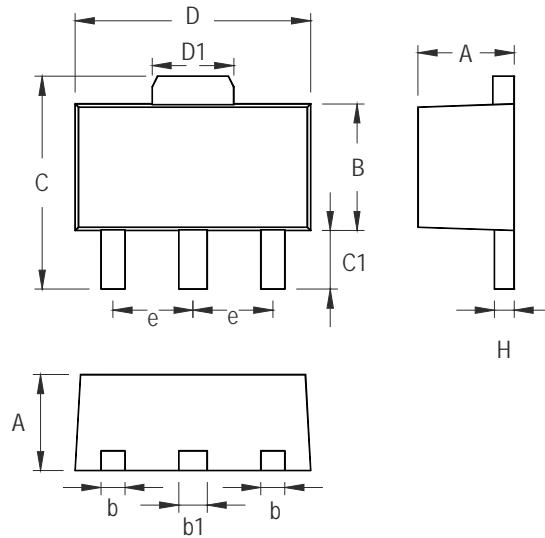

Symbol	Dimensions In Millimeters		Dimensions In Inches	
	Min	Max	Min	Max
A	1.397	1.600	0.055	0.063
b	0.356	0.483	0.014	0.019
B	2.388	2.591	0.094	0.102
b1	0.406	0.533	0.016	0.021
C	3.937	4.242	0.155	0.167
C1	0.787	1.194	0.031	0.047
D	4.394	4.597	0.173	0.181
D1	1.397	1.753	0.055	0.069
e	1.448	1.549	0.057	0.061
H	0.356	0.432	0.014	0.017

3-Lead SOT-89 Surface Mount Package

Richtek Technology Corporation

Headquarter
 5F, No. 20, Taiyuen Street, Chupei City
 Hsinchu, Taiwan, R.O.C.
 Tel: (8863)5526789 Fax: (8863)5526611

Richtek Technology Corporation

Taipei Office (Marketing)
 5F, No. 95, Minchiuan Road, Hsintien City
 Taipei County, Taiwan, R.O.C.
 Tel: (8862)86672399 Fax: (8862)86672377
 Email: marketing@richtek.com

Information that is provided by Richtek Technology Corporation is believed to be accurate and reliable. Richtek reserves the right to make any change in circuit design, specification or other related things if necessary without notice at any time. No third party intellectual property infringement of the applications should be guaranteed by users when integrating Richtek products into any application. No legal responsibility for any said applications is assumed by Richtek.