

## GENERAL DESCRIPTION

The SP6200 and SP6201 are CMOS Low Dropout (LDO) regulators designed to meet a broad range of applications that require accuracy, speed and ease of use.

These LDOs offer extremely low quiescent current which only increases slightly under load, thus providing advantages in ground current performance over bipolar LDOs. The LDOs handle an extremely wide load range and guarantee stability with a 1 $\mu$ F ceramic output capacitor. They have excellent low frequency Power Supply Rejection Ratio (PSRR), not found in other CMOS LDOs and thus offer exceptional Line Regulation. High frequency PSRR is better than 40dB up to 400kHz. Load Regulation is excellent and temperature stability is comparable to bipolar LDOs. An enable feature is provided on all versions.

Both LDOs are available in fixed & adjustable output voltage versions and come in an industry standard 5-pin SOT-23 and small 2X3mm 8-pin DFN packages. A  $V_{OUT}$  good indicator is provided on all fixed output versions.

## APPLICATIONS

- **Battery-Powered Systems**
- **Medical Equipments**
- **MP3/CD Players**
- **Digital Cameras**

## FEATURES

- **100mA/200mA Output Current**
  - SP6200: 100mA – SP6201: 200mA
  - Low Dropout Voltage: 160mV @ 100mA
- **2.5V to 6.0V Input Voltage**
  - Fixed and Adjustable Output Voltage
  - 2% Output Voltage Accuracy
- **Ultra Low Ground Current:**
  - 200 $\mu$ A @ 200mA & 28 $\mu$ A @ 100 $\mu$ A Load
- **Tight Load and Line Regulation**
- **78dB PSRR @ 1KHz**
- **RESET/Power Good Output**
- **Logic-Controlled Electronic Enable**
- **Unconditionally Stable with 1 $\mu$ F Ceramic Capacitor**
- **Current Limit and Thermal Protection**
- **RoHS Compliant "Green"/Halogen Free 5-Pin SOT23 and 8-Pin DFN Packages**

## TYPICAL APPLICATION DIAGRAM

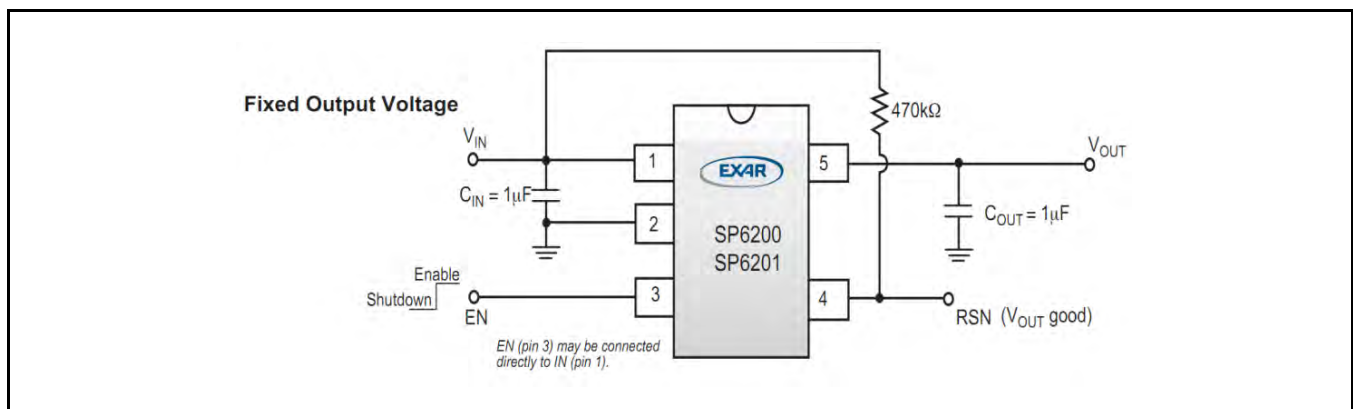

Fig. 1: SP6200 / SP6201 Application Diagram



**ABSOLUTE MAXIMUM RATINGS**

These are stress ratings only and functional operation of the device at these ratings or any other above those indicated in the operation sections of the specifications below is not implied. Exposure to absolute maximum rating conditions for extended periods of time may affect reliability.

Supply Input Voltage (V <sub>IN</sub> )	-2V to 7V
Output Voltage (V <sub>OUT</sub> )	-0.6 to (V <sub>IN</sub> + 1V)
Enable Input Voltage (V <sub>EN</sub> )	-2V to 7V
Storage Temperature	-65°C to +150°C
Power Dissipation	Internally Limited <sup>1</sup>
Lead Temperature (Soldering, 5 sec)	260°C

**OPERATING RATINGS**

Input Voltage Range V <sub>IN</sub>	+2.5V to +6V
Enable Input Voltage (V <sub>EN</sub> )	0V to 6V
Junction Temperature Range	-40°C to 125°C
Thermal Resistance	
SOT-23-5 (θ <sub>JA</sub> )	191°C/W
DFN-8 (θ <sub>JA</sub> )	59°C/W

Note 1: Maximum power dissipation can be calculated using the formula: PD = (T<sub>J(max)</sub> - T<sub>A</sub>) / θ<sub>JA</sub>, where T<sub>J(max)</sub> is the junction temperature, T<sub>A</sub> is the ambient temperature and θ<sub>JA</sub> is the junction-to-ambient thermal resistance. θ<sub>JC</sub> is 6°C/W for this package. Exceeding the maximum allowable power dissipation will result in excessive die temperature and the regulator will go into thermal shutdown mode.

**ELECTRICAL SPECIFICATIONS**

Specifications with standard type are for an Operating Junction Temperature of T<sub>J</sub> = 25°C only; limits applying over the full Operating Junction Temperature range are denoted by a “•”. Minimum and Maximum limits are guaranteed through test, design, or statistical correlation. Typical values represent the most likely parametric norm at T<sub>J</sub> = 25°C, and are provided for reference purposes only. Unless otherwise indicated, V<sub>IN</sub> = (V<sub>OUT</sub> + 1V), V<sub>OUT</sub> = 5V for Adjustable version, C<sub>IN</sub> = 1.0µF, C<sub>OUT</sub> = 1.0µF and I<sub>L</sub> = 100µA, T<sub>J</sub> = 25°C.

Parameter	Min.	Typ.	Max.	Units	Conditions
Output Voltage Accuracy, (V <sub>O</sub> )	-2		2	%	• Variation from specified V <sub>OUT</sub>
	-3		3		
Reference Voltage	1.213	1.250	1.287	V	• Adjustable version only
Output Voltage Temperature Coefficient <sup>2</sup> (ΔV <sub>O</sub> /ΔT)		60		ppm/°C	
Minimum Supply Voltage		2.50	2.70	V	I <sub>L</sub> = 100µA I <sub>L</sub> = 50mA I <sub>L</sub> = 100mA I <sub>C</sub> = 200mA
		2.55	2.80	V	
		2.70	2.95	V	
		3.00	3.50	V	
Line Regulation, (ΔV <sub>O</sub> /V <sub>IN</sub> )		0.03	0.2	%/V	• V <sub>IN</sub> = (V <sub>OUT</sub> + 1V) to 6V
Load Regulation <sup>3</sup> (ΔV <sub>O</sub> /V <sub>O</sub> )		0.07	0.25	%	• I <sub>L</sub> = 0.1mA to 100mA, SP6200 • I <sub>L</sub> = 0.1mA to 200mA, SP6201
		0.14	0.50	%	
SP6200-1.5V & 1.8 Load Reg.		0.3	1	%	I <sub>L</sub> = 0.1mA to 100mA, V <sub>IN</sub> = 2.95V I <sub>L</sub> = 0.1mA to 200mA, V <sub>IN</sub> = 3.5V
SP6201-1.5V & 1.8 Load Reg.		0.3	1	%	
Dropout Voltage <sup>4</sup> (V <sub>IN</sub> - V <sub>O</sub> ) (Not applicable to voltage options below 2.7V)		0.2	4	mV	• I <sub>L</sub> = 100µA
			7		
		70	120	mV	• I <sub>L</sub> = 50mA
			160		
		160	250	mV	• I <sub>L</sub> = 100mA
			300		
		320	400	mV	• I <sub>L</sub> = 200mA, SP6201 Only
		500			
Shutdown Quiescent Current (I <sub>GND</sub> )		0.01	1	µA	• V <sub>EN</sub> ≥ 0.4V
Ground Pin Current <sup>5</sup> (I <sub>GND</sub> )		28	40	µA	• V <sub>EN</sub> ≥ 2.0V, I <sub>L</sub> = 100 µA
			45		
		110	200	µA	• V <sub>EN</sub> ≥ 2.0V, I <sub>L</sub> = 100 mA, SP6200 only (for 1.5 & 1.8, V <sub>IN</sub> = 2.95)
			250		
		200	400	µA	• V <sub>EN</sub> ≥ 2.0V, I <sub>L</sub> = 200mA, SP6201 Only (for 1.5 & 1.8, V <sub>IN</sub> = 3.5)
			500		
Power Supply Rejection Ratio, (PSRR)		78		dB	Frequency = 100Hz, I <sub>L</sub> = 10mA
		40			Frequency = 400Hz, I <sub>L</sub> = 10mA
Current Limit, (I <sub>CL</sub> )	100	140	200	mA	• SP6200

Parameter	Min.	Typ.	Max.	Units	Conditions
	300	420	600		• SP6201
Thermal Limit		162		°C	Turns On
		147			Turns Off
Thermal Regulation <sup>6</sup> ( $\Delta V_O/\Delta P_D$ )		0.05		%/W	
Output Noise, ( $e_{NO}$ )		150		$\mu V_{rms}$	$I_L = 50mA$ , $C_L = 1\mu F$ 0.1 $\mu F$ from $V_{OUT}$ to Adj. 10Hz to 100kHz
<b>ENABLE INPUT</b>					
Enable Input Logic-Low Voltage, ( $V_{IL}$ )			0.4	V	• Regulator Shutdown
Enable Input Logic-High Voltage, ( $V_{IH}$ )	1.6			V	• Regulator Enabled
Enable Input Current, ( $I_{IL}$ ), ( $I_{IH}$ )		0.01	1	$\mu A$	• $V_{IL} < 0.4V$
		0.01	1	$\mu A$	• $V_{IH} > 2.0V$
Reset Not Output	-2	-4	-6	%	Threshold

Note 2: Output voltage temperature coefficient is defined as the worst case voltage change divided by the total temperature range.

Note 3: Load Regulation is measured at constant junction temperature using low duty cycle pulse testing. Parts are tested for load regulation in the load range; from 0.1mA to 100mA, SP6200; from 0.1mA to 200mA, SP6201. Changes in output voltage due to heating effects are covered by the thermal regulation specification. Not applicable to output voltages less than 2.5V.

Note 4: Dropout Voltage is defined as the input to output differential at which the output voltage drops 2% below its nominal value measured at 1V differential. Not applicable to output voltages less than 2.7V.

Note 5: Ground pin current is the regulator quiescent current. The total current drawn from the supply is the sum of the load current plus the ground pin current.

Note 6: **Thermal regulation is defined as the change in output voltage at a time "t" after a change** in power dissipation is applied, excluding load or line regulation effects. Specifications are for a 100mA load pulse at  $V_{IN} = 6V$  for  $t = 10ms$ .

### BLOCK DIAGRAMS

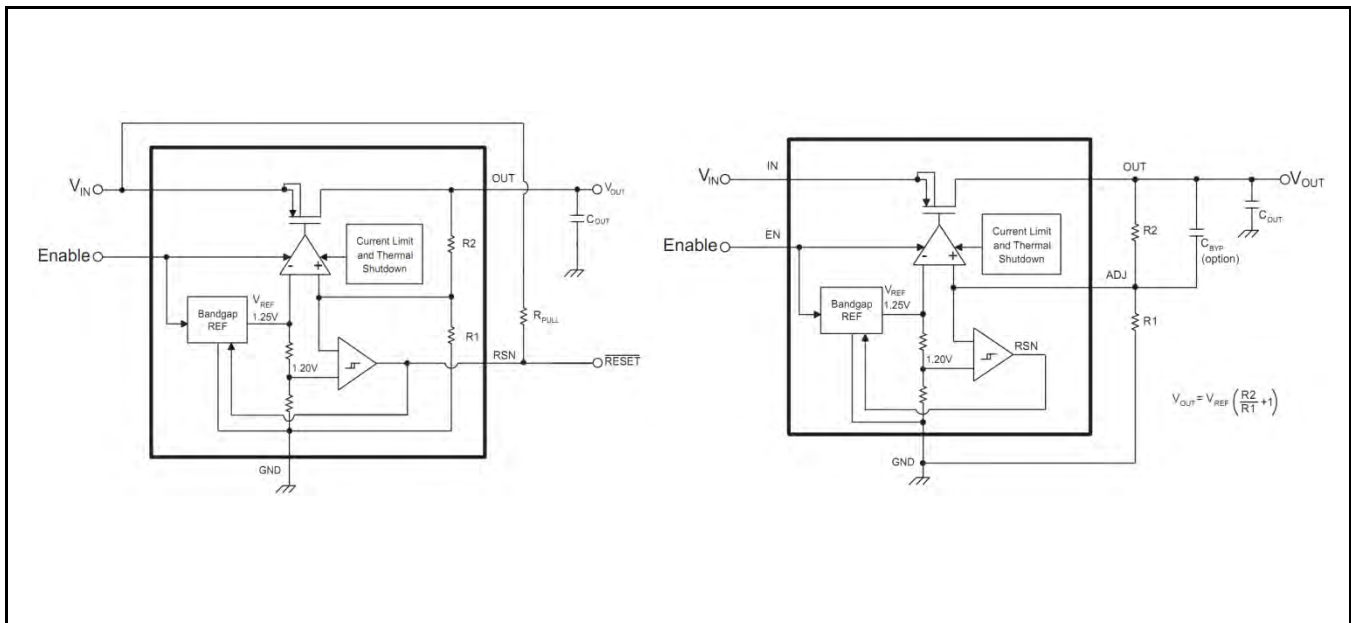

Fig. 2: Fixed Voltage and Adjustable Regulators

### PIN ASSIGNMENT

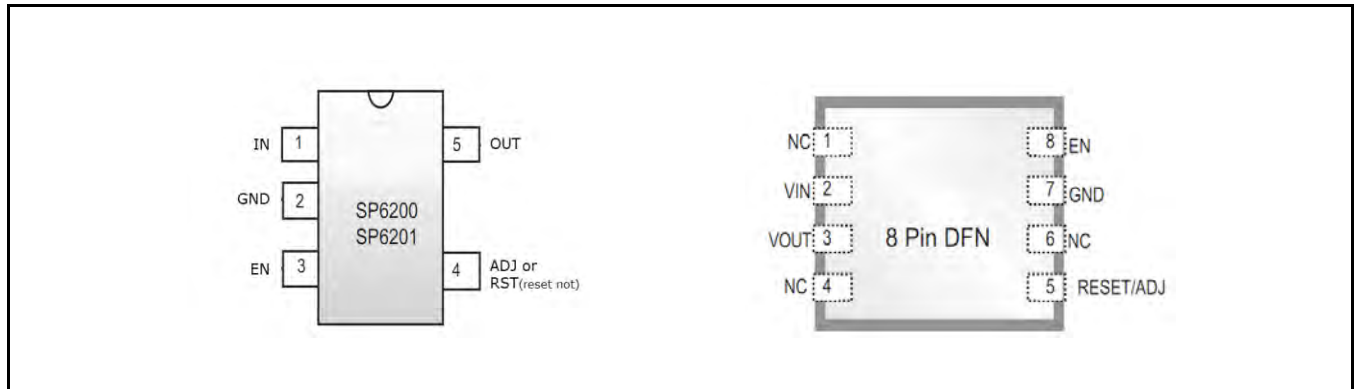

Fig. 3: SP6200 / SP6201 Pin Assignment

### PIN DESCRIPTION

#### SOT 23-5

Name	SOT-23-5	Description
IN	1	Power Supply Input
GND	2	Ground Terminal
EN	3	Enable/Shutdown Input – CMOS or TTL compatible Input - Logic high = enable - Logic low = shutdown
RST(Reset not)/ADJ	4	Reset/Power Good - Fixed voltage option: Open Drain indicating that $V_{OUT}$ is good.  Adjustable Input – Adjustable voltage option: Adjustable regulator feedback input. Connect to a resistive voltage-Divider network.
OUT	5	Regulator Output Voltage

#### 8 PIN DFN

Name	DFN-8	Description
NC	1	No Connect
$V_{IN}$	2	Power Supply Input
$V_{OUT}$	3	Regulator Output Voltage
NC	4	No Connect
RESET/ADJ	5	Reset/Power Good - Fixed voltage option: Open Drain indicating that $V_{OUT}$ is good.  Adjustable Input – Adjustable voltage option: Adjustable regulator feedback input. Connect to a resistive voltage-Divider network.
NC	6	No Connect
NC	7	No Connect
EN	8	Enable/Shutdown Input – CMOS or TTL compatible Input - Logic high = enable - Logic low = shutdown



# SP6200 / SP6201

## 100mA/200mA Micropower CMOS LDO Regulators

### ORDERING INFORMATION

Part Number	Temperature Range	Marking	Package	Packing Quantity	Voltage Option	Note 1		
SP6200EM5-L-3-0	-40°C ≤ T <sub>J</sub> ≤ +125°C	E30	SOT-23-5	Bulk	3.0V	Halogen Free		
SP6200EM5-L-3-0/TR				2.5K/Tape & Reel				
SP6201EM5-L	-40°C ≤ T <sub>J</sub> ≤ +125°C	FADJ	SOT-23-5	Bulk	Adjustable	Halogen Free		
SP6201EM5-L/TR				2.5K/Tape & Reel				
SP6201EM5-L-1-5		F15		Bulk	1.5V	Halogen Free		
SP6201EM5-L-1-5/TR				2.5K/Tape & Reel				
SP6201EM5-L-1-8		F18		Bulk	1.8V	Halogen Free		
SP6201EM5-L-1-8/TR				2.5K/Tape & Reel				
SP6201EM5-L-2-5		F25		Bulk	2.5V	Halogen Free		
SP6201EM5-L-2-5/TR				2.5K/Tape & Reel				
SP6201EM5-L-2-85		F285		Bulk	2.85V	Halogen Free		
SP6201EM5-L-2-85/TR				2.5K/Tape & Reel				
SP6201EM5-L-3-0		F30		Bulk	3.0V	Halogen Free		
SP6201EM5-L-3-0/TR				2.5K/Tape & Reel				
SP6201EM5-L-3-3		F33		Bulk	3.3V	Halogen Free		
SP6201EM5-L-3-3/TR				2.5K/Tape & Reel				
SP6201EM5-G-3-3		UBWW		Bulk	3.3V	Halogen Free		
SP6201EM5-G-3-3/TR				2.5K/Tape & Reel				
SP6201EM5-L-5-0		F50		Bulk	5.0V	Halogen Free		
SP6201EM5-L-5-0/TR				2.5K/Tape & Reel				
SP6201ER-L		-40°C ≤ T <sub>J</sub> ≤ +125°C		A0 YWW XXX	DFN8	Bulk	Adjustable	Halogen Free
SP6201ER-L/TR						3K/Tape & Reel		
SP6201ER-L-1-8	B0 YWW XXX		Bulk	1.8V		Halogen Free		
SP6201ER-L-1-8/TR			3K/Tape & Reel					
SP6201ER-L-3-3	C0 YWW XXX		Bulk	3.3V		Halogen Free		
SP6201ER-L-3-3/TR			3K/Tape & Reel					

"Y" = Year - "WW" = Work Week - "XXX" = Lot Number; when applicable.

### TYPICAL PERFORMANCE CHARACTERISTICS

All data taken at 25°C,  $V_{IN} = 5.5V$ ,  $I_O = 0.1mA$ ,  $C_{IN} = C_{OUT} = 1\mu F$ , unless otherwise specified - Schematic and BOM from Application Information section of this datasheet.

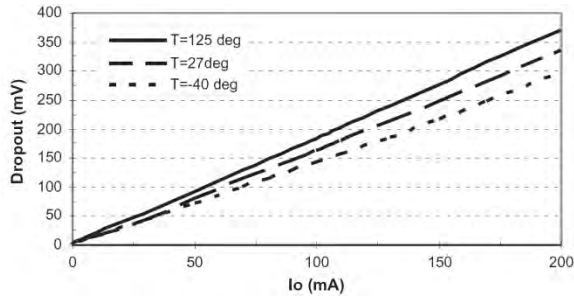

Fig. 4: Dropout vs.  $I_O$  (SP6201 fixed 3.0V)

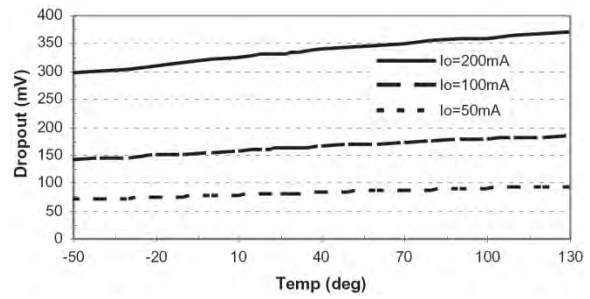

Fig. 5: Dropout vs. Temp (SP6201 fixed 3.0V)

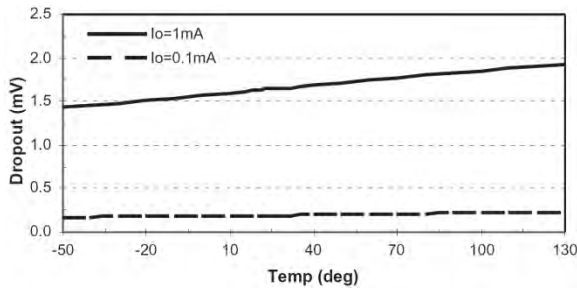

Fig. 6: Dropout vs. Temp (SP6201 fixed 3.0V)

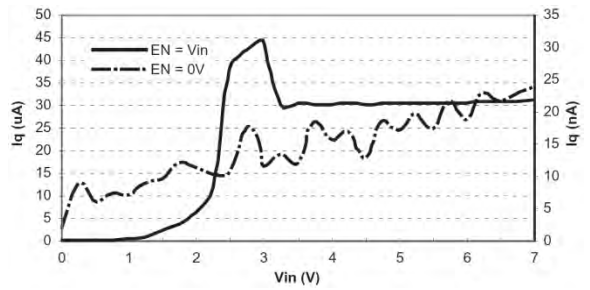

Fig. 7:  $I_q$  vs.  $V_{in}$  (fixed 3.0V,  $I_O=0\mu A$ )

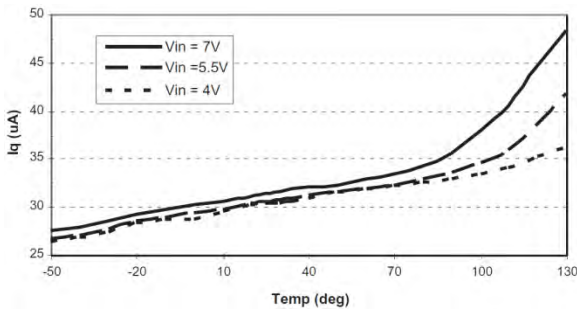

Fig. 8:  $I_q$  vs. Temp (SP6201 fixed 3.0V,  $EN=V_{in}$ ,  $I_O=0\mu A$ )

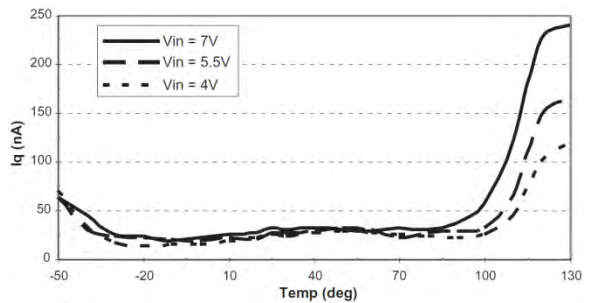

Fig. 9:  $I_q$  vs. Temp (SP6201 fixed 3.0V,  $EN=0V$ ,  $I_O=0\mu A$ )



# SP6200 / SP6201

## 100mA/200mA Micropower CMOS LDO Regulators

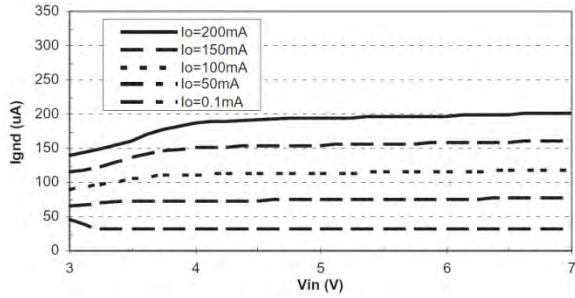

Fig. 10:  $I_{GND}$  vs.  $V_{IN}$  (SP6201 fixed 3.0V)

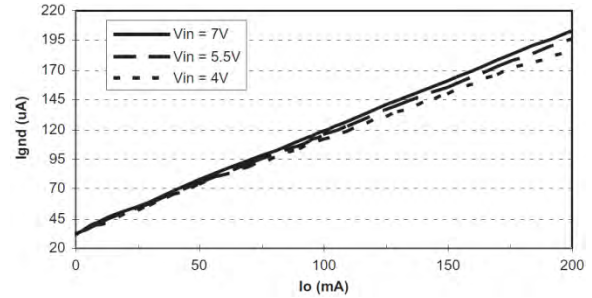

Fig. 11:  $I_{GND}$  vs.  $I_O$  (SP6201 fixed 3.0V)

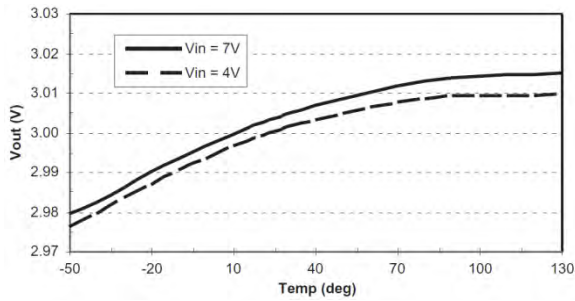

Fig. 12:  $V_{OUT}$  vs. Temp (fixed 3.0V)

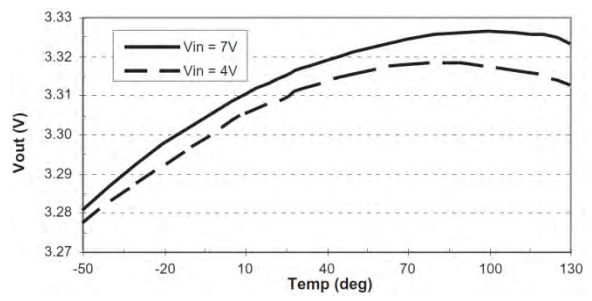

Fig. 13:  $V_{OUT}$  vs. Temp (fixed 3.3V)

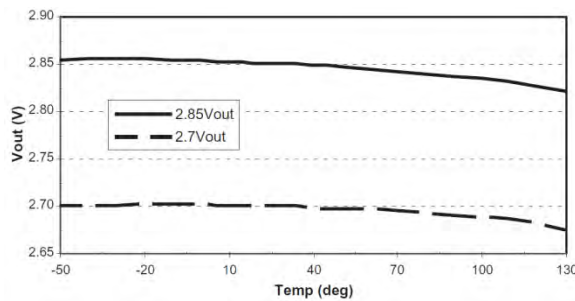

Fig. 14:  $V_{OUT}$  vs. Temp (adjustable)

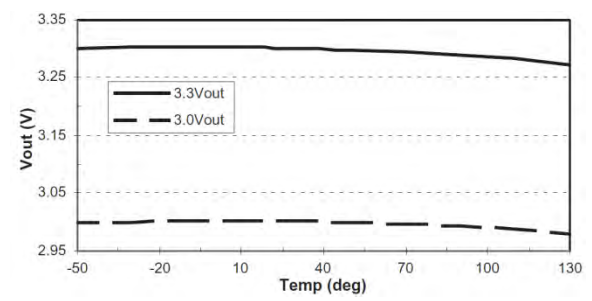

Fig. 15:  $V_{OUT}$  vs. Temp (adjustable)

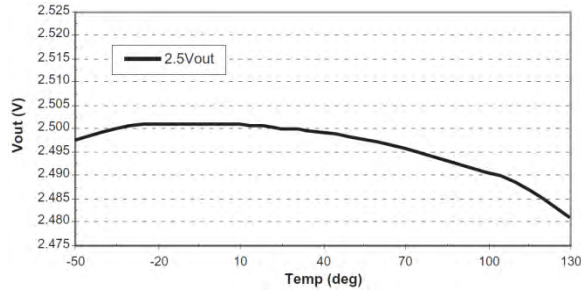

Fig. 16:  $V_{OUT}$  vs. Temp (adjustable)

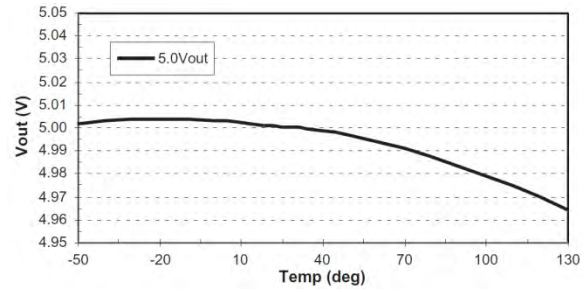

Fig. 17:  $V_{OUT}$  vs. Temp (adjustable)

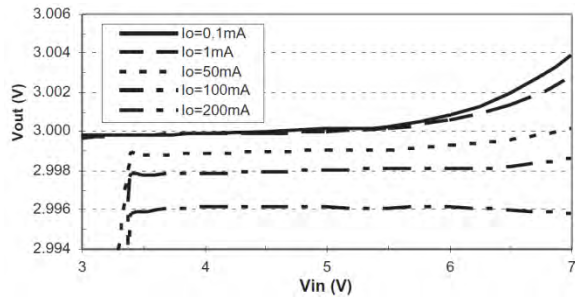

Fig. 18: Line Regulation (SP6201 fixed 3.0V)

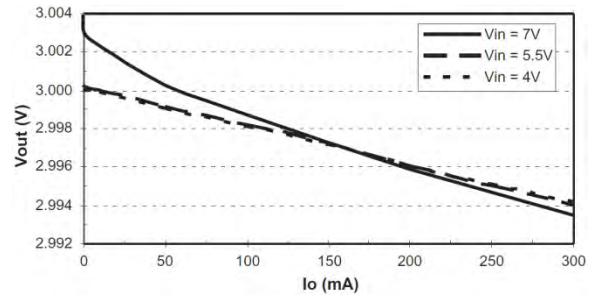

Fig. 19: Load Regulation (SP6201 fixed 3.0V)

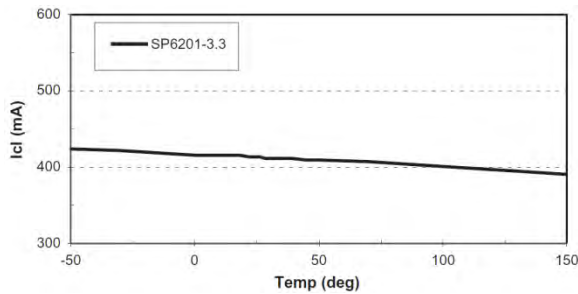

Fig. 20: Current Limit vs. Temp (fixed 3.3V,  $V_{IN}=4V$ )

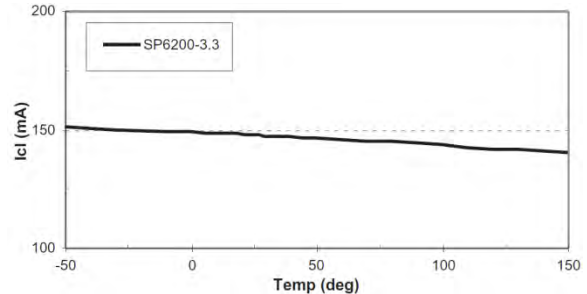

Fig. 21: Current Limit vs. Temp (fixed 3.3V,  $V_{IN}=4V$ )



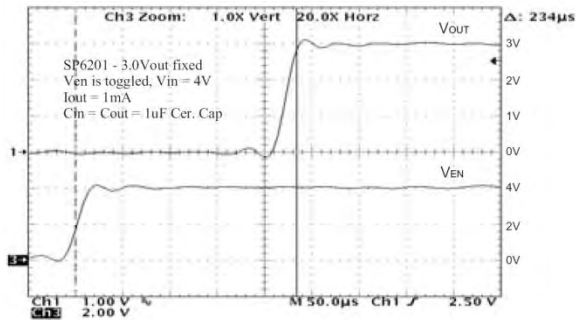

Fig. 22: Turn on time,  $I_O=1\text{mA}$ ,  $4V_{IN}$

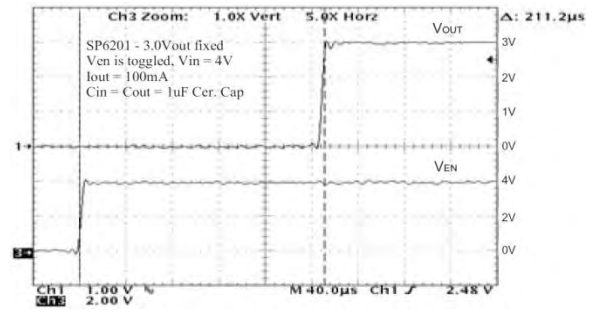

Fig. 23: Turn on time,  $I_O=100\text{mA}$ ,  $4V_{IN}$

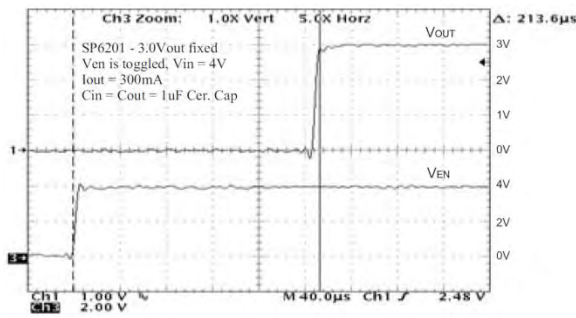

Fig. 24: Turn on time,  $I_O=300\text{mA}$ ,  $4V_{IN}$

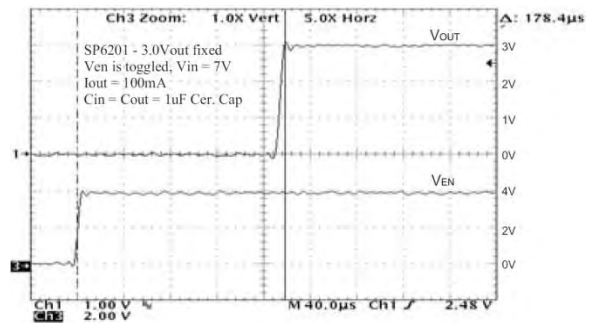

Fig. 25: Turn on time,  $I_O=100\text{mA}$ ,  $7V_{IN}$

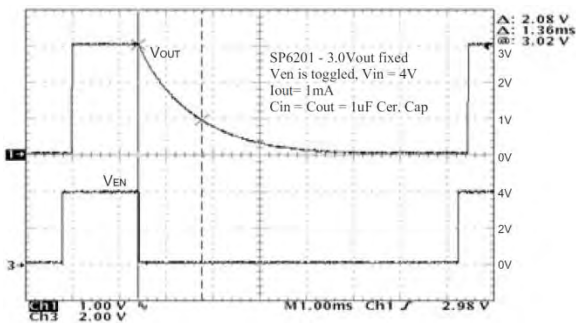

Fig. 26: Turn off time,  $I_O=1\text{mA}$ ,  $4V_{IN}$

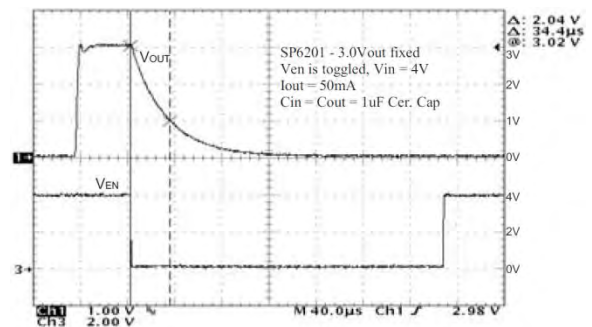

Fig. 27: Turn off time,  $I_O=50\text{mA}$ ,  $4V_{IN}$

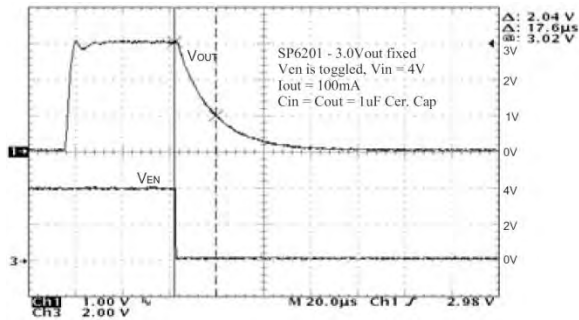

Fig. 28: Turn off time,  $I_o=100\text{mA}$ ,  $4V_{IN}$

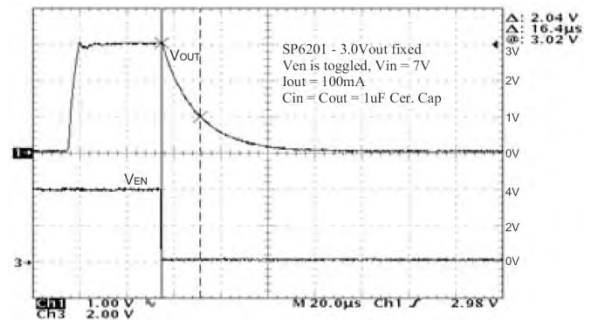

Fig. 29: Turn off time,  $I_o=100\text{mA}$ ,  $7V_{IN}$

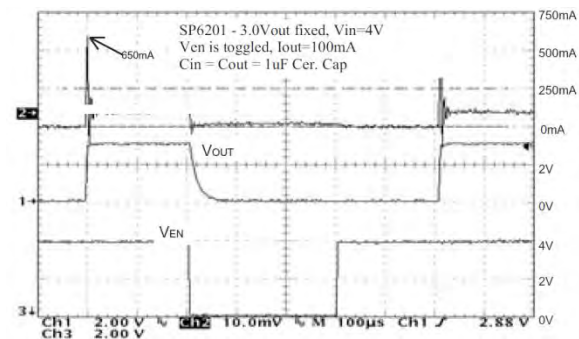

Fig. 30: Inrush Current,  $I_o=100\text{mA}$

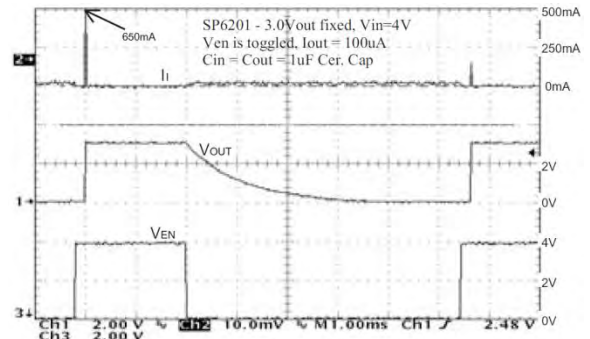

Fig. 31: Inrush Current,  $I_o=100\mu\text{A}$

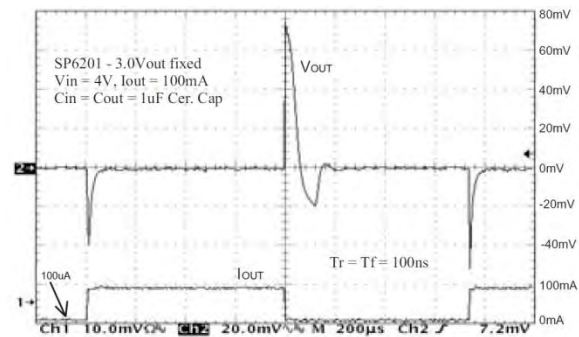

Fig. 32: Load Transient Response, 100mA step,  $4V_{IN}$

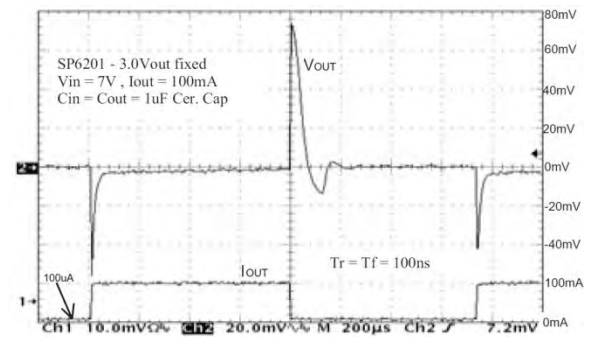

Fig. 33: Load Transient Response, 100mA step,  $7V_{IN}$

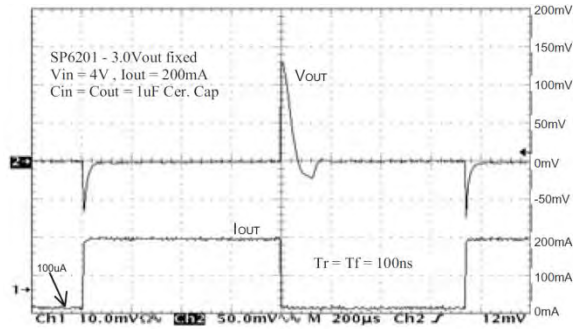

Fig. 34: Load Transient Response, 200mA step, 4V<sub>IN</sub>

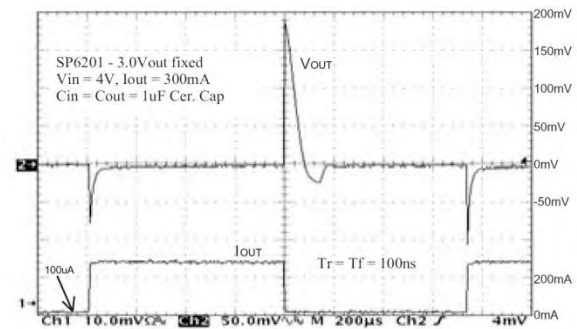

Fig. 35: Load Transient Response, 300mA step, 4V<sub>IN</sub>

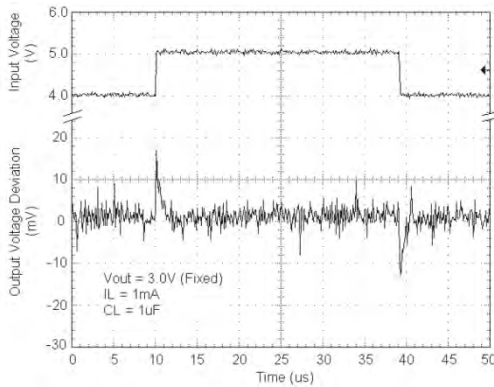

Fig. 36: Line Transient Response

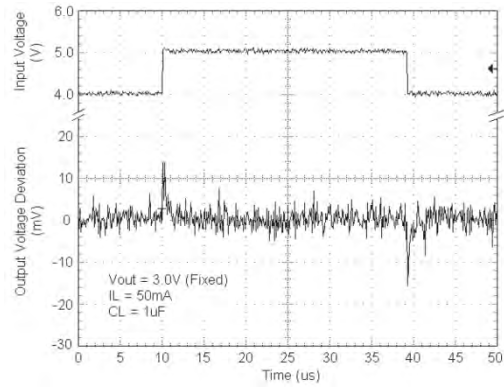

Fig. 37: Line Transient Response

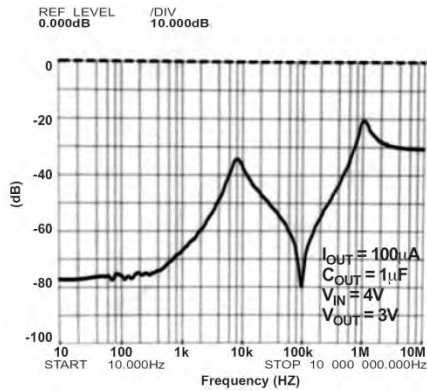

Fig. 38: Power Supply Rejection Ratio

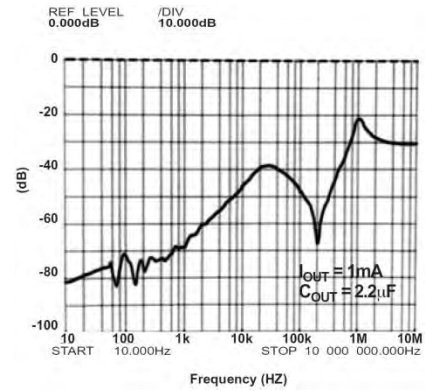

Fig. 39: Power Supply Rejection Ratio

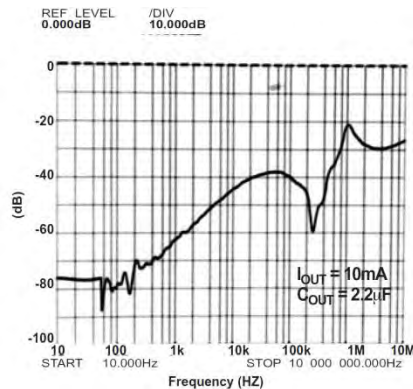

Fig. 40: Power Supply Rejection Ratio

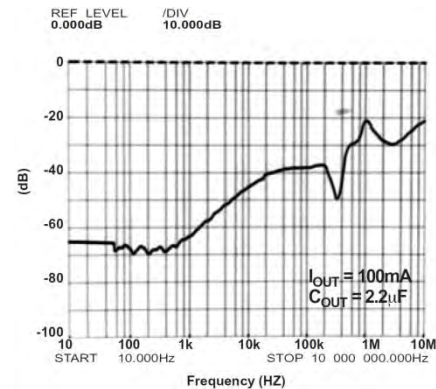

Fig. 41: Power Supply Rejection Ratio

## THEORY OF OPERATION

### GENERAL OVERVIEW

The SP6200 and SP6201 are CMOS LDOs designed to meet a broad range of applications that require accuracy, speed and ease of use. These LDOs offer extremely low quiescent current which only increases slightly under load, thus providing advantages in ground current performance over bipolar LDOs. The LDOs handle an extremely wide **load range and guarantee stability with a 1µF ceramic output capacitor**. They have excellent low frequency PSRR, not found in other CMOS LDOs and thus offer exceptional Line Regulation. High frequency PSRR is better than 40dB up to 400kHz. Load Regulation is excellent and temperature stability is comparable to bipolar LDOs. Thus, overall system accuracy is maintained under all DC and AC conditions. Enable feature is provided on all versions. A Vout good indicator (RSN pin) is provided in all the fixed output voltage devices. An adjustable output version is also available. Current Limit and Thermal protection is provided internally and is well controlled.

### ARCHITECTURE

The SP6200 and SP6201 are only different in their current limit threshold. The SP6200 has a current limit of 140mA, while the SP6201 current limit is 420mA. The SP6201 can provide pulsed load current of 300mA. The

LDOs have a two stage amplifier which handles an extremely wide **load range (10µA to 300mA) and guarantees stability with a 1µF ceramic load capacitor**. The LDO amplifier has excellent gain and thus touts PSRR performance not found in other CMOS LDOs. The amplifier guarantees no overshoot on power up or while enabled through the EN pin. The amplifier also contains an active pull down, so that when the load is removed quickly the output voltage transient is minimal; thus output deviation due to load transient is small and fairly well matched when connecting and disconnecting the load.

An accurate 1.250V bandgap reference is bootstrapped to the output in fixed output versions of 2.7V and higher. This increases both the low frequency and high frequency PSRR. The adjustable version also has the bandgap reference bootstrapped to the output, thus the lowest externally programmable output voltage is 2.7V. The 2.5V fixed output version has the bandgap always connected to the Vin pin. Unlike many LDOs, the bandgap reference is not brought out for filtering by the user. This tradeoff was made to maintain good PSRR at high frequency (PSRR can be degraded in a system due to switching noise coupling into this pin). Also, often leakages of the bypass capacitor or other components cause an error on this high impedance bandgap node. Thus, this tradeoff has been made with "ease of use" in mind.

### PROTECTION

Current limit behavior is very well controlled, providing less than 10% variation in the current limit threshold over the entire temperature range for both SP6200 and SP6201. The SP6200 has a current limit of 140mA, while the SP6201 has a current limit of 420mA. Thermal shutdown activates at 162°C and deactivates at 147°C. Thermal shutdown is very repeatable with only a 2 to 3 degree variation from device to device. Thermal shutdown changes by only 1 to 2 degrees with  $V_{in}$  change from 4V to 7V.

### ENABLE (SHUTDOWN NOT) INPUT

The LDOs are turned off by pulling the EN pin low and turned on by pulling it high. If it is not necessary to shut down the LDO, the EN (pin 3) should be tied to IN (pin 1) to keep the regulator output on at all time. The enable threshold is 0.9V and does not change more than 100mV over the entire temperature and  $V_{IN}$  voltage range. The lot to lot variations in Enable Threshold are also within 100mV. Shutdown current is guaranteed to be  $<1\mu A$  without requiring the user to pull enable all the way to 0V. Standard TTL or CMOS levels will transition the device from totally on to totally off.

### RESET NOT ( $V_{OUT}$ GOOD) OUTPUT

An accurate  $V_{OUT}$  good indicator is provided on all the fixed output version devices, pin 4 (RSN), Figure 1. This is an open drain, logic output that can be used to hold a microprocessor or microcontroller in a RESET condition when its power supplied by  $V_{OUT}$  is 4% out of nominal regulation. A 1% hysteresis is included in the Reset Not function, so that false alarms are not issued as a result of LDO's output noise. The Reset Not function reacts in 10 to 50 $\mu s$ .

### ADJUSTABLE OUTPUT VERSION

The adjustable version can be programmed to any voltage from 2.7V to 6V for the industrial temperature range; 2.5V to 6V for the commercial temperature range. The output cannot be programmed below 2.5V due a headroom restriction. Since the bandgap is

bootstrapped to the output, the output voltage must be above the minimum bandgap supply voltage. The bandgap requires 2.7V or greater at -40°C and requires 2.5V or greater at 0°C. The regulator's output can be adjusted to a specific output voltage by using two external resistors, see block diagram. The resistor's set the output voltage based on the following equation:

$$V_{OUT} = 1.25 \times \left(1 + \frac{R_2}{R_1}\right)$$

Resistor values are not critical because the ADJ node has a high input impedance, but for **best results use resistors of 470k $\Omega$  or less.** A capacitor from ADJ to  $V_{OUT}$  pin provides improved noise performance as is shown in the following plot.

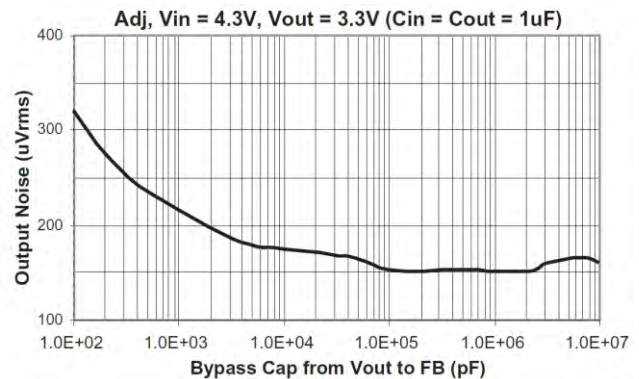

Fig. 42: Noise Performance 10Hz to 100kHz

### INPUT CAPACITOR

A small capacitor, 1 $\mu F$  or higher, is required from  $V_{IN}$  to GND to create a high frequency bypass for the LDO amplifier. Any ceramic or tantalum capacitor may be used at the input. Capacitor ESR (effective series resistance) should be smaller than 3 $\Omega$ .

### OUTPUT CAPACITOR

An output capacitor is required between  $V_{OUT}$  and GND to prevent oscillation; a capacitance as low as 0.22 $\mu F$  can fulfill stability requirements in most applications. A 1 $\mu F$  capacitor will ensure unconditional stability from no load to full load over the entire input voltage, output voltage and temperature range. Larger capacitor values improve the



# SP6200 / SP6201

## 100mA/200mA Micropower CMOS LDO Regulators

regulator's transient response. The output capacitor value may be increased without limit. The output capacitor should have an ESR (effective series resistance) below  $5\Omega$  and a resonant frequency above 1MHz.

### No Load Stability

The SP6200/SP6201 will remain stable and in regulation with no external load (other than the internal voltage driver) unlike many other voltage regulators. This is especially important in CMOS RAM keep-alive applications.

### Thermal Considerations

The SP6200 is designed to provide 100mA of continuous current, while the SP6201 will provide 200mA of continuous current. Maximum power dissipation can be calculated based on the output current and the voltage drop across the part. To determine the maximum power dissipation in the package, use the junction-to-ambient thermal resistance of the device and the following basic equation:

$$P_D = \frac{(T_{J(MAX)} - T_A)}{\theta_{JA}}$$

$T_{J(MAX)}$  is the maximum junction temperature of the die and is  $125^\circ\text{C}$ .  $T_A$  is the ambient operating.  $\theta_{JA}$  is the junction-to-ambient thermal resistance for the regulator and is layout dependent.

The actual power dissipation of the regulator circuit can be determined using one simple equation:

$$P_D = \frac{125^\circ\text{C} - 25^\circ\text{C}}{191^\circ\text{C}/\text{W}} = 0.52\text{W}$$

$$P_D = (V_{IN} - V_{OUT}) \times I_{OUT} + V_{IN} \times I_{GND} \\ \cong (V_{IN} - V_{OUT}) \times I_{OUT}$$

Substituting  $P_{D(max)}$  for  $P_D$  and solving for the operating conditions that are critical to the application will give the maximum operating conditions for the regulator circuit. For example, if we are operating the SP6201- 3.0V at room temperature, with a SOT-23-5 package on a 4 layer standard board we can determine the maximum input voltage for a set output current.

$$P_D = \frac{125^\circ\text{C} - 25^\circ\text{C}}{191^\circ\text{C}/\text{W}} = 0.52\text{W}$$

To prevent the device from entering thermal shutdown, maximum power dissipation cannot be exceeded. Using the output voltage of 3.0V and an output current of 200mA, the maximum input voltage can be determined. Ground pin current can be taken from the electrical spec's table ( $I_{GND}=200\mu\text{A}$  at  $I_{OUT}=200\text{mA}$ ). The maximum input voltage is determined as follows:

$$0.52\text{W} = (V_{IN} - 3.0\text{V}) \times 200\text{mA} + (V_{IN} \times 0.2\text{mA})$$

Solving for  $V_{IN}$ , we get:

$$V_{IN} = \frac{0.52\text{W} + 0.6\text{W}}{200.2\text{mA}}$$

After calculations, we find that the maximum input voltage of a 3.0V application at 200mA of output current in an SOT-23-5 package is 5.59V.

### Dual-Supply Operation

When used in dual supply systems where the regulator load is returned to a negative supply, the output voltage must be diode clamped to ground.

### PACKAGE SPECIFICATION

#### 5 PIN SOT-23

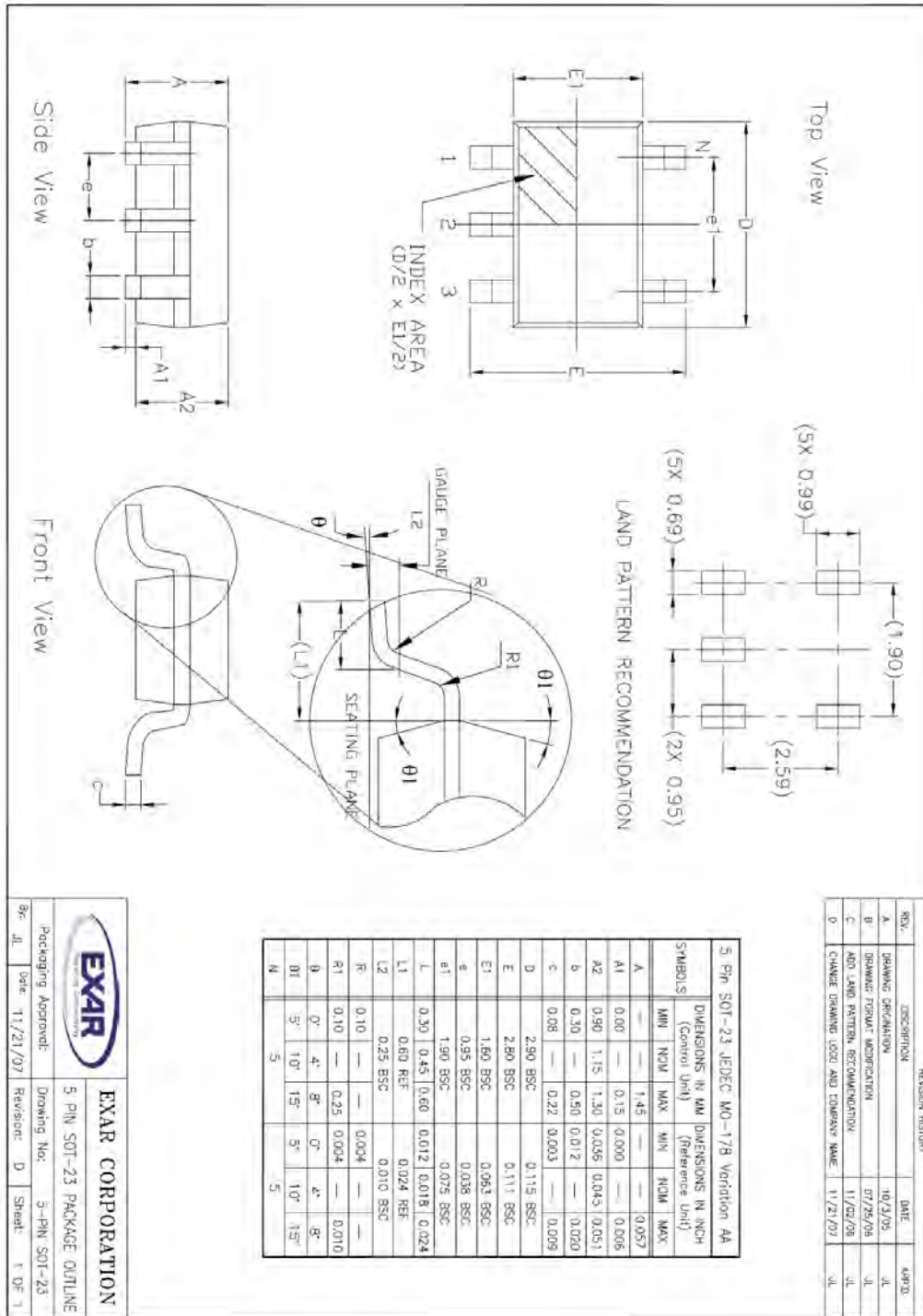

### 8-PIN DFN

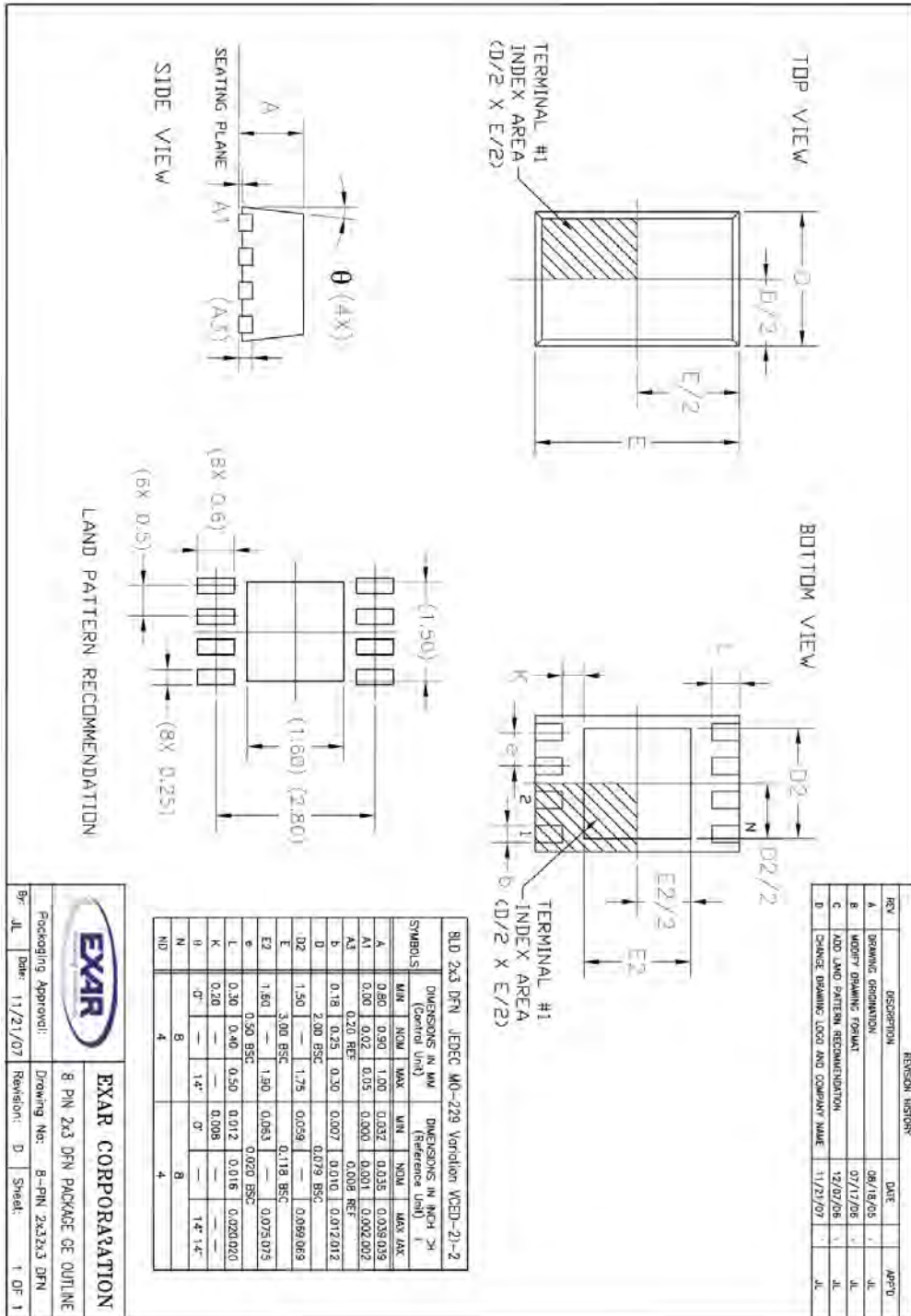





# SP6200 / SP6201

## 100mA/200mA Micropower CMOS LDO Regulators

### REVISION HISTORY

Revision	Date	Description
2.0.0	03/28/2012	Reformatted Data Sheet Includes top package marking update.
2.1.0	05/29/2012	Corrected typographical error on page 1.

### FOR FURTHER ASSISTANCE

Email:

[customersupport@exar.com](mailto:customersupport@exar.com)

Exar Technical Documentation:

<http://www.exar.com/TechDoc/default.aspx?>



### EXAR CORPORATION

#### HEADQUARTERS AND SALES OFFICES

48720 Kato Road

Fremont, CA 94538 – USA

Tel.: +1 (510) 668-7000

Fax: +1 (510) 668-7030

[www.exar.com](http://www.exar.com)

### NOTICE

EXAR Corporation reserves the right to make changes to the products contained in this publication in order to improve design, performance or reliability. EXAR Corporation assumes no responsibility for the use of any circuits described herein, conveys no license under any patent or other right, and makes no representation that the circuits are free of patent infringement. Charts and schedules contained here in are only for illustration purposes and may vary depending upon a **user's specific application**. While the information in this publication has been carefully checked; no responsibility, however, is assumed for inaccuracies.

EXAR Corporation does not recommend the use of any of its products in life support applications where the failure or malfunction of the product can reasonably be expected to cause failure of the life support system or to significantly affect its safety or effectiveness. Products are not authorized for use in such applications unless EXAR Corporation receives, in writing, assurances to its satisfaction that: (a) the risk of injury or damage has been minimized; (b) the user assumes all such risks; (c) potential liability of EXAR Corporation is adequately protected under the circumstances.

Reproduction, in part or whole, without the prior written consent of EXAR Corporation is prohibited.